

EFM[®]32

... the world's most energy friendly microcontrollers

EFM32G222 DATASHEET

F128/F64/F32

- **ARM Cortex-M3 CPU platform**
 - High Performance 32-bit processor @ up to 32 MHz
 - Memory Protection Unit
 - Wake-up Interrupt Controller
- **Flexible Energy Management System**
 - 20 nA @ 3 V Shutoff Mode
 - 0.6 µA @ 3 V Stop Mode, including Power-on Reset, Brown-out Detector, RAM and CPU retention
 - 0.9 µA @ 3 V Deep Sleep Mode, including RTC with 32.768 kHz oscillator, Power-on Reset, Brown-out Detector, RAM and CPU retention
 - 45 µA/MHz @ 3 V Sleep Mode
 - 180 µA/MHz @ 3 V Run Mode, with code executed from flash
- **128/64/32 KB Flash**
- **16/16/8 KB RAM**
- **37 General Purpose I/O pins**
 - Configurable Push-pull, Open-drain, pull-up/down, input filter, drive strength
 - Configurable peripheral I/O locations
 - 16 asynchronous external interrupts
- **8 Channel DMA Controller**
- **8 Channel Peripheral Reflex System (PRS) for autonomous inter-peripheral signaling**
- **Hardware AES with 128/256-bit keys in 54/75 cycles**
- **Timers/Counters**
 - 3x 16-bit Timer/Counter
 - 3x3 Compare/Capture/PWM channels
 - Dead-Time Insertion on TIMER0
 - 16-bit Low Energy Timer
 - 24-bit Real-Time Counter
 - 2x 8-bit Pulse Counter
 - Watchdog Timer with dedicated RC oscillator @ 50 nA
- **Communication interfaces**
 - 2x Universal Synchronous/Asynchronous Receiver/Transmitter
 - UART/SPI/SmartCard (ISO 7816)/IrDA
 - Triple buffered full/half-duplex operation
 - Low Energy UART
 - Autonomous operation with DMA in Deep Sleep Mode
 - I²C Interface with SMBus support
 - Address recognition in Stop Mode
- **Ultra low power precision analog peripherals**
 - 12-bit 1 Msamples/s Analog to Digital Converter
 - 4 single ended channels/2 differential channels
 - On-chip temperature sensor
 - Conversion tailgating for predictable latency
 - 12-bit 500 ksamples/s Digital to Analog Converter
 - 2x Analog Comparator
 - Capacitive sensing with up to 12 inputs
 - Supply Voltage Comparator
- **Ultra efficient Power-on Reset and Brown-Out Detector**
- **Pre-Programmed Serial Bootloader**
- **Temperature range -40 to 85 °C**
- **Single power supply 1.85 to 3.8 V**
- **TQFP48 package**

32-bit ARM Cortex-M0, Cortex-M3 and Cortex-M4F microcontrollers for:

- Energy, gas, water and smart metering
- Health and fitness applications
- Smart accessories
- Alarm and security systems
- Industrial and home automation
- www.energymicro.com/gecko



1 Ordering Information

Table 1.1 (p. 2) shows the available EFM32G222 devices.

Table 1.1. Ordering Information

Ordering Code	Flash (KB)	RAM (KB)	Max Speed (MHz)	Supply Voltage (V)	Temperature	Package
EFM32G222F32-QFP48	32	8	32	1.85 - 3.8	-40 - 85 °C	TQFP48
EFM32G222F64-QFP48	64	16	32	1.85 - 3.8	-40 - 85 °C	TQFP48
EFM32G222F128-QFP48	128	16	32	1.85 - 3.8	-40 - 85 °C	TQFP48

Visit www.energymicro.com for information on global distributors and representatives or contact sales@energymicro.com for additional information.

2 System Summary

2.1 System Introduction

The EFM32 MCUs are the world's most energy friendly microcontrollers. With a unique combination of the powerful 32-bit ARM Cortex-M3, innovative low energy techniques, short wake-up time from energy saving modes, and a wide selection of peripherals, the EFM32G microcontroller is well suited for any battery operated application as well as other systems requiring high performance and low-energy consumption. This section gives a short introduction to each of the modules in general terms and also shows a summary of the configuration for the EFM32G222 devices. For a complete feature set and in-depth information on the modules, the reader is referred to the *EFM32G Reference Manual*.

A block diagram of the EFM32G222 is shown in Figure 2.1 (p. 3) .

Figure 2.1. Block Diagram

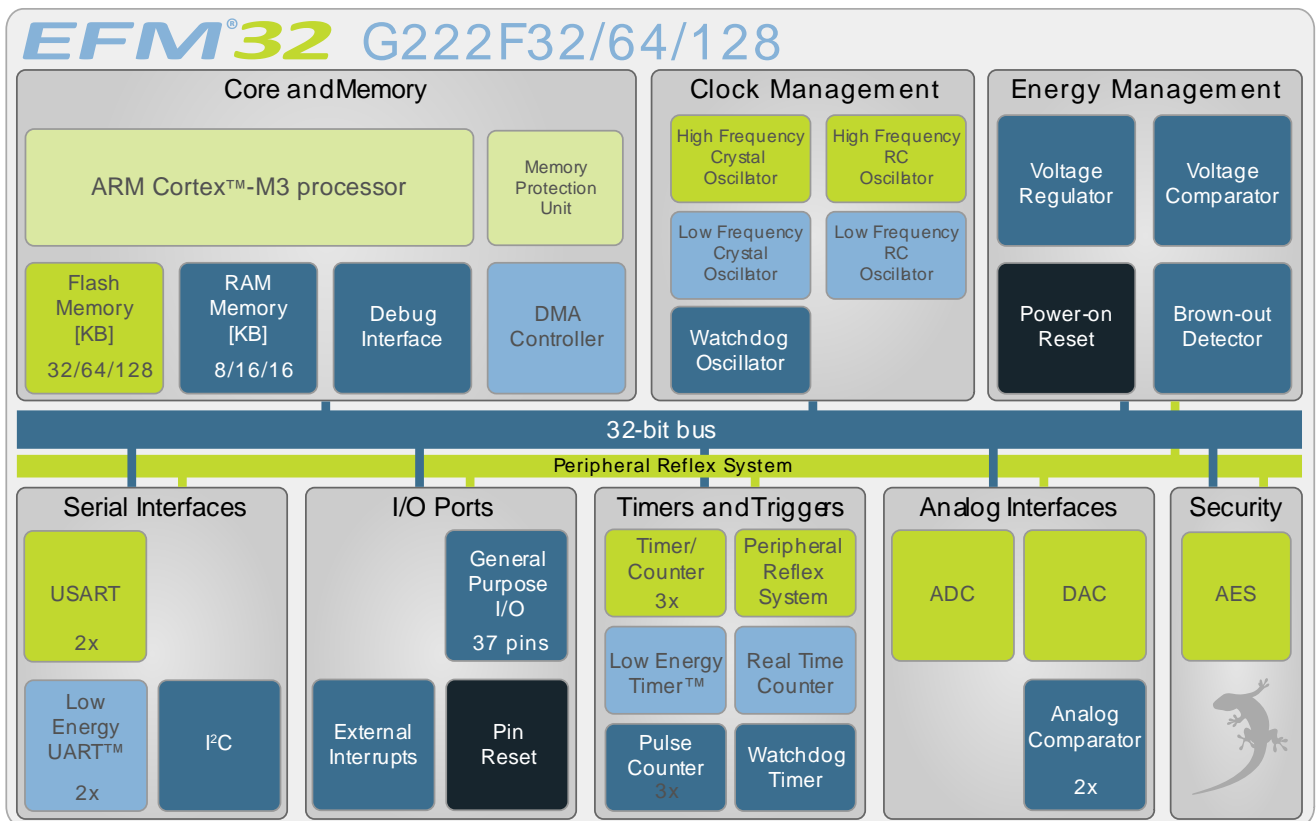

2.1.1 ARM Cortex-M3 Core

The ARM Cortex-M3 includes a 32-bit RISC processor which can achieve as much as 1.25 Dhrystone MIPS/MHz. A Memory Protection Unit with support for up to 8 memory segments is included, as well as a Wake-up Interrupt Controller handling interrupts triggered while the CPU is asleep. The EFM32 implementation of the Cortex-M3 is described in detail in *EFM32G Cortex-M3 Reference Manual*.

2.1.2 Debug Interface (DBG)

This device includes hardware debug support through a 2-pin serial-wire debug interface . In addition there is also a 1-wire Serial Wire Viewer pin which can be used to output profiling information, data trace and software-generated messages.

2.1.3 Memory System Controller (MSC)

The Memory System Controller (MSC) is the program memory unit of the EFM32G microcontroller. The flash memory is readable and writable from both the Cortex-M3 and DMA. The flash memory is divided

into two blocks; the main block and the information block. Program code is normally written to the main block. Additionally, the information block is available for special user data and flash lock bits. There is also a read-only page in the information block containing system and device calibration data. Read and write operations are supported in the energy modes EM0 and EM1.

2.1.4 Direct Memory Access Controller (DMA)

The Direct Memory Access (DMA) controller performs memory operations independently of the CPU. This has the benefit of reducing the energy consumption and the workload of the CPU, and enables the system to stay in low energy modes when moving for instance data from the USART to RAM or from the External Bus Interface to a PWM-generating timer. The DMA controller uses the PL230 μ DMA controller licensed from ARM.

2.1.5 Reset Management Unit (RMU)

The RMU is responsible for handling the reset functionality of the EFM32G.

2.1.6 Energy Management Unit (EMU)

The Energy Management Unit (EMU) manage all the low energy modes (EM) in EFM32G microcontrollers. Each energy mode manages if the CPU and the various peripherals are available. The EMU can also be used to turn off the power to unused SRAM blocks.

2.1.7 Clock Management Unit (CMU)

The Clock Management Unit (CMU) is responsible for controlling the oscillators and clocks on-board the EFM32G. The CMU provides the capability to turn on and off the clock on an individual basis to all peripheral modules in addition to enable/disable and configure the available oscillators. The high degree of flexibility enables software to minimize energy consumption in any specific application by not wasting power on peripherals and oscillators that are inactive.

2.1.8 Watchdog (WDOG)

The purpose of the watchdog timer is to generate a reset in case of a system failure, to increase application reliability. The failure may e.g. be caused by an external event, such as an ESD pulse, or by a software failure.

2.1.9 Peripheral Reflex System (PRS)

The Peripheral Reflex System (PRS) system is a network which lets the different peripheral module communicate directly with each other without involving the CPU. Peripheral modules which send out Reflex signals are called producers. The PRS routes these reflex signals to consumer peripherals which apply actions depending on the data received. The format for the Reflex signals is not given, but edge triggers and other functionality can be applied by the PRS.

2.1.10 Inter-Integrated Circuit Interface (I2C)

The I²C module provides an interface between the MCU and a serial I²C-bus. It is capable of acting as both a master and a slave, and supports multi-master buses. Both standard-mode, fast-mode and fast-mode plus speeds are supported, allowing transmission rates all the way from 10 kbit/s up to 1 Mbit/s. Slave arbitration and timeouts are also provided to allow implementation of an SMBus compliant system. The interface provided to software by the I²C module, allows both fine-grained control of the transmission process and close to automatic transfers. Automatic recognition of slave addresses is provided in all energy modes.

2.1.11 Universal Synchronous/Asynchronous Receiver/Transmitter (USART)

The Universal Synchronous Asynchronous serial Receiver and Transmitter (USART) is a very flexible serial I/O module. It supports full duplex asynchronous UART communication as well as RS-485, SPI, MicroWire and 3-wire. It can also interface with ISO7816 SmartCards and IrDA devices.

2.1.12 Pre-Programmed Serial Bootloader

The bootloader presented in application note AN0003 is pre-programmed in the device at factory. Auto-baud and destructive write are supported. The autobaud feature, interface and commands are described further in the application note.

2.1.13 Low Energy Universal Asynchronous Receiver/Transmitter (LEUART)

The unique LEUART[™], the Low Energy UART, is a UART that allows two-way UART communication on a strict power budget. Only a 32.768 kHz clock is needed to allow UART communication up to 9600 baud/s. The LEUART includes all necessary hardware support to make asynchronous serial communication possible with minimum of software intervention and energy consumption.

2.1.14 Timer/Counter (TIMER)

The 16-bit general purpose Timer has 3 compare/capture channels for input capture and compare/Pulse-Width Modulation (PWM) output. TIMER0 also includes a Dead-Time Insertion module suitable for motor control applications.

2.1.15 Real Time Counter (RTC)

The Real Time Counter (RTC) contains a 24-bit counter and is clocked either by a 32.768 kHz crystal oscillator, or a 32 kHz RC oscillator. In addition to energy modes EM0 and EM1, the RTC is also available in EM2. This makes it ideal for keeping track of time since the RTC is enabled in EM2 where most of the device is powered down.

2.1.16 Low Energy Timer (LETIMER)

The unique LETIMER[™], the Low Energy Timer, is a 16-bit timer that is available in energy mode EM2 in addition to EM1 and EM0. Because of this, it can be used for timing and output generation when most of the device is powered down, allowing simple tasks to be performed while the power consumption of the system is kept at an absolute minimum. The LETIMER can be used to output a variety of waveforms with minimal software intervention. It is also connected to the Real Time Counter (RTC), and can be configured to start counting on compare matches from the RTC.

2.1.17 Pulse Counter (PCNT)

The Pulse Counter (PCNT) can be used for counting pulses on a single input or to decode quadrature encoded inputs. It runs off either the internal LFACTLK or the PCNTn_S0IN pin as external clock source. The module may operate in energy mode EM0 – EM3.

2.1.18 Analog Comparator (ACMP)

The Analog Comparator is used to compare the voltage of two analog inputs, with a digital output indicating which input voltage is higher. Inputs can either be one of the selectable internal references or from external pins. Response time and thereby also the current consumption can be configured by altering the current supply to the comparator.

2.1.19 Voltage Comparator (VCMP)

The Voltage Supply Comparator is used to monitor the supply voltage from software. An interrupt can be generated when the supply falls below or rises above a programmable threshold. Response time and thereby also the current consumption can be configured by altering the current supply to the comparator.

2.1.20 Analog to Digital Converter (ADC)

The ADC is a Successive Approximation Register (SAR) architecture, with a resolution of up to 12 bits at up to one million samples per second. The integrated input mux can select inputs from 4 external pins and 6 internal signals.

2.1.21 Digital to Analog Converter (DAC)

The Digital to Analog Converter (DAC) can convert a digital value to an analog output voltage. The DAC is fully differential rail-to-rail, with 12-bit resolution. It has one single ended output buffer connected to channel 0. The DAC may be used for a number of different applications such as sensor interfaces or sound output.

2.1.22 Advanced Encryption Standard Accelerator (AES)

The AES accelerator performs AES encryption and decryption with 128-bit or 256-bit keys. Encrypting or decrypting one 128-bit data block takes 52 HFCORECLK cycles with 128-bit keys and 75 HFCORECLK cycles with 256-bit keys. The AES module is an AHB slave which enables efficient access to the data and key registers. All write accesses to the AES module must be 32-bit operations, i.e. 8- or 16-bit operations are not supported.

2.1.23 General Purpose Input/Output (GPIO)

In the EFM32G222, there are 37 General Purpose Input/Output (GPIO) pins, which are divided into ports with up to 16 pins each. These pins can individually be configured as either an output or input. More advanced configurations like open-drain, filtering and drive strength can also be configured individually for the pins. The GPIO pins can also be overridden by peripheral pin connections, like Timer PWM outputs or USART communication, which can be routed to several locations on the device. The GPIO supports up to 16 asynchronous external pin interrupts, which enables interrupts from any pin on the device. Also, the input value of a pin can be routed through the Peripheral Reflex System to other peripherals.

2.2 Configuration Summary

The features of the EFM32G222 is a subset of the feature set described in the EFM32G Reference Manual. Table 2.1 (p. 6) describes device specific implementation of the features.

Table 2.1. Configuration Summary

Module	Configuration	Pin Connections
Cortex-M3	Full configuration	NA
DBG	Full configuration	DBG_SWCLK, DBG_SWDIO, DBG_SWO
MSC	Full configuration	NA
DMA	Full configuration	NA
RMU	Full configuration	NA

Module	Configuration	Pin Connections
EMU	Full configuration	NA
CMU	Full configuration	CMU_OUT0, CMU_OUT1
WDOG	Full configuration	NA
PRS	Full configuration	NA
I2C0	Full configuration	I2C0_SDA, I2C0_SCL
USART0	IrDA	US0_TX, US0_RX, US0_CLK, US0_CS
USART1		US1_TX, US1_RX, US1_CLK, US1_CS
LEUART0	Full configuration	LEU0_TX, LEU0_RX
TIMER0	Full configuration with DTI.	TIM0_CC[2:0], TIM0_CDTI[2:0]
TIMER1	Full configuration	TIM1_CC[2:0]
TIMER2	Full configuration	TIM2_CC[2:0]
RTC	Full configuration	NA
LETIMER0	Full configuration	LET0_O[1:0]
PCNT0	8-bit count register	PCNT0_S[1:0]
PCNT1	8-bit count register	PCNT1_S[1:0]
ACMP0	Full configuration	ACMP0_CH[4:0], ACMP0_O
ACMP1	Full configuration	ACMP1_CH[7:0], ACMP1_O
VCMP	Full configuration	NA
ADC0	Full configuration	ADC0_CH[7:4]
DAC0	Full configuration	DAC0_OUT[1]
AES	Full configuration	NA
GPIO	37 pins	Available pins are shown in Table 4.3 (p. 51)

2.3 Memory Map

The *EFM32G222* memory map is shown in Figure 2.2 (p. 8), with RAM and Flash sizes for the largest memory configuration.

Figure 2.2. EFM32G222 Memory Map with largest RAM and Flash sizes

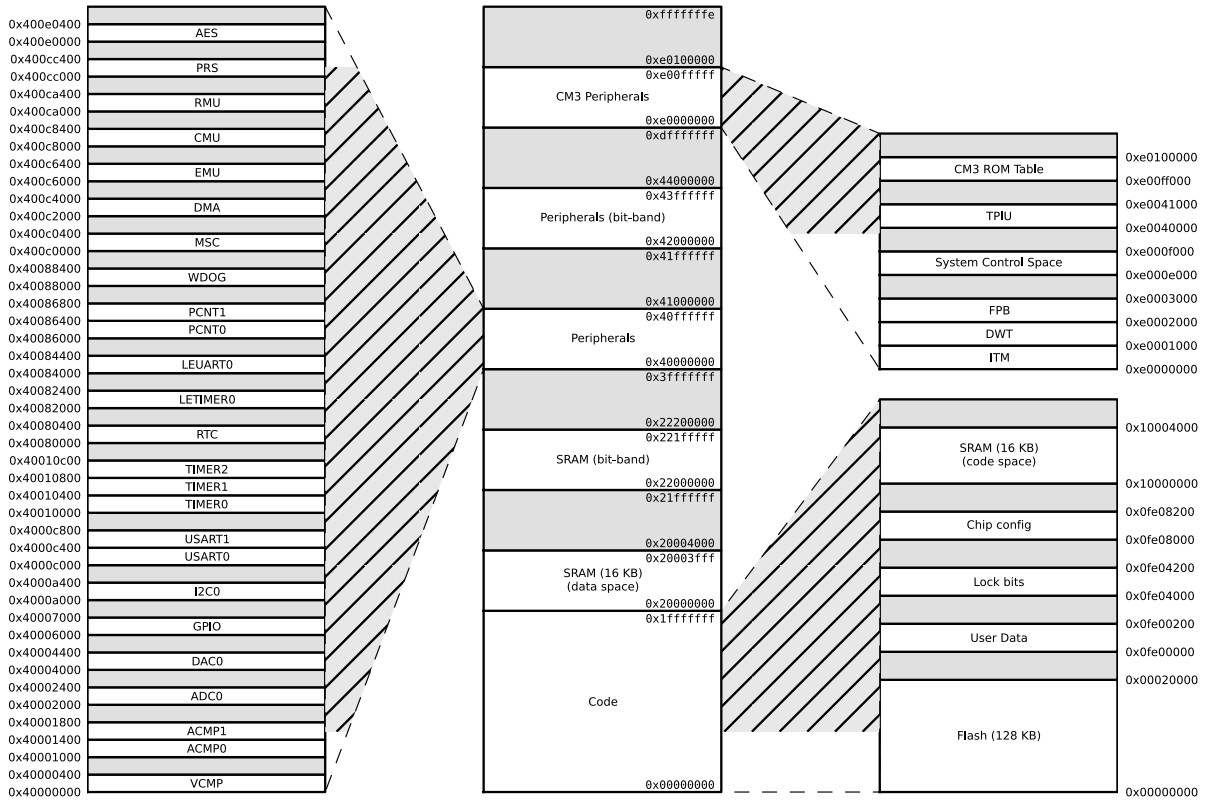

3 Electrical Characteristics

3.1 Test Conditions

3.1.1 Typical Values

The typical data are based on $T_{AMB}=25^{\circ}\text{C}$ and $V_{DD}=3.0\text{ V}$, as defined in Table 3.2 (p. 9), by simulation and/or technology characterisation unless otherwise specified.

3.1.2 Minimum and Maximum Values

The minimum and maximum values represent the worst conditions of ambient temperature, supply voltage and frequencies, as defined in Table 3.2 (p. 9), by simulation and/or technology characterisation unless otherwise specified.

3.2 Absolute Maximum Ratings

The absolute maximum ratings are stress ratings, and functional operation under such conditions are not guaranteed. Stress beyond the limits specified in Table 3.1 (p. 9) may affect the device reliability or cause permanent damage to the device. Functional operating conditions are given in Table 3.2 (p. 9).

Table 3.1. Absolute Maximum Ratings

Symbol	Parameter	Condition	Min	Typ	Max	Unit
T_{STG}	Storage temperature range		-40		150 ¹	$^{\circ}\text{C}$
T_S	Maximum soldering temperature	Latest IPC/JEDEC J-STD-020 Standard			260	$^{\circ}\text{C}$
V_{DDMAX}	External main supply voltage		0		3.8	V
V_{IOPIN}	Voltage on any I/O pin		-0.3		$V_{DD}+0.3$	V

¹Based on programmed devices tested for 10000 hours at 150°C . Storage temperature affects retention of preprogrammed calibration values stored in flash. Please refer to the Flash section in the Electrical Characteristics for information on flash data retention for different temperatures.

3.3 General Operating Conditions

3.3.1 General Operating Conditions

Table 3.2. General Operating Conditions

Symbol	Parameter	Min	Typ	Max	Unit
T_{AMB}	Ambient temperature range	-40		85	$^{\circ}\text{C}$
V_{DDOP}	Operating supply voltage	1.85		3.8	V
f_{APB}	Internal APB clock frequency			32	MHz
f_{AHB}	Internal AHB clock frequency			32	MHz

3.3.2 Environmental

Table 3.3. Environmental

Symbol	Parameter	Condition	Min	Typ	Max	Unit
V _{ESDHBM}	ESD (Human Body Model HBM)	T _{AMB} =25°C			2	kV
V _{ESDCDM}	ESD (Charged Device Model, CDM)	T _{AMB} =25°C			1	kV

Latch-up sensitivity test passed level A according to JEDEC JESD 78B method Class II, 85°C.

3.4 Current Consumption

Table 3.4. Current Consumption

Symbol	Parameter	Condition	Min	Typ	Max	Unit
I _{EM0}	EM0 current. No prescaling. Running prime number calculation code from Flash.	32 MHz HF XO, all peripheral clocks disabled, V _{DD} = 3.0 V		180		μA/MHz
		28 MHz HFRCO, all peripheral clocks disabled, V _{DD} = 3.0 V		181	235	μA/MHz
		21 MHz HFRCO, all peripheral clocks disabled, V _{DD} = 3.0 V		183	237	μA/MHz
		14 MHz HFRCO, all peripheral clocks disabled, V _{DD} = 3.0 V		185	243	μA/MHz
		11 MHz HFRCO, all peripheral clocks disabled, V _{DD} = 3.0 V		186	246	μA/MHz
		7 MHz HFRCO, all peripheral clocks disabled, V _{DD} = 3.0 V		191	257	μA/MHz
		1 MHz HFRCO, all peripheral clocks disabled, V _{DD} = 3.0 V		220		μA/MHz
I _{EM1}	EM1 current	32 MHz HF XO, all peripheral clocks disabled, V _{DD} = 3.0 V		45		μA/MHz
		28 MHz HFRCO, all peripheral clocks disabled, V _{DD} = 3.0 V		47	62	μA/MHz
		21 MHz HFRCO, all peripheral clocks disabled, V _{DD} = 3.0 V		48	64	μA/MHz
		14 MHz HFRCO, all peripheral clocks disabled, V _{DD} = 3.0 V		50	69	μA/MHz
		11 MHz HFRCO, all peripheral clocks disabled, V _{DD} = 3.0 V		51	72	μA/MHz
		7 MHz HFRCO, all peripheral clocks disabled, V _{DD} = 3.0 V		56	83	μA/MHz
		1 MHz HFRCO. all peripheral clocks disabled, V _{DD} = 3.0 V		103		μA/MHz
I _{EM2}	EM2 current	EM2 current with RTC at 1 Hz, RTC prescaled to 1kHz, 32 kHz LFRCO, V _{DD} = 3.0 V, T _{AMB} =25°C		0.9		μA
		EM2 current with RTC at 1 Hz, RTC prescaled to 1kHz, 32 kHz LFRCO, V _{DD} = 3.0 V, T _{AMB} =85°C		3.0	6.0	μA
I _{EM3}	EM3 current	V _{DD} = 3.0 V, T _{AMB} =25°C		0.59		μA
		V _{DD} = 3.0 V, T _{AMB} =85°C		2.75	5.8	μA
I _{EM4}	EM4 current	V _{DD} = 3.0 V, T _{AMB} =25°C		0.02		μA
		V _{DD} = 3.0 V, T _{AMB} =85°C		0.25	0.7	μA

Figure 3.1. EM0 Current consumption while executing prime number calculation code from flash with HFRCO running at 28MHz

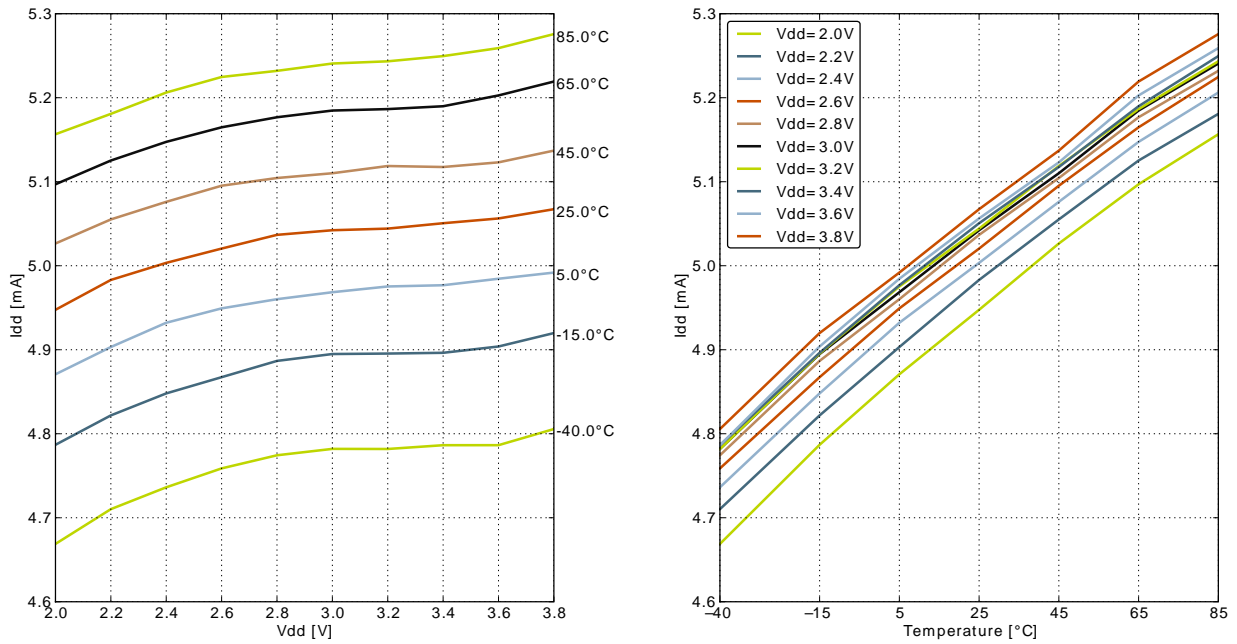

Figure 3.2. EM0 Current consumption while executing prime number calculation code from flash with HFRCO running at 21MHz

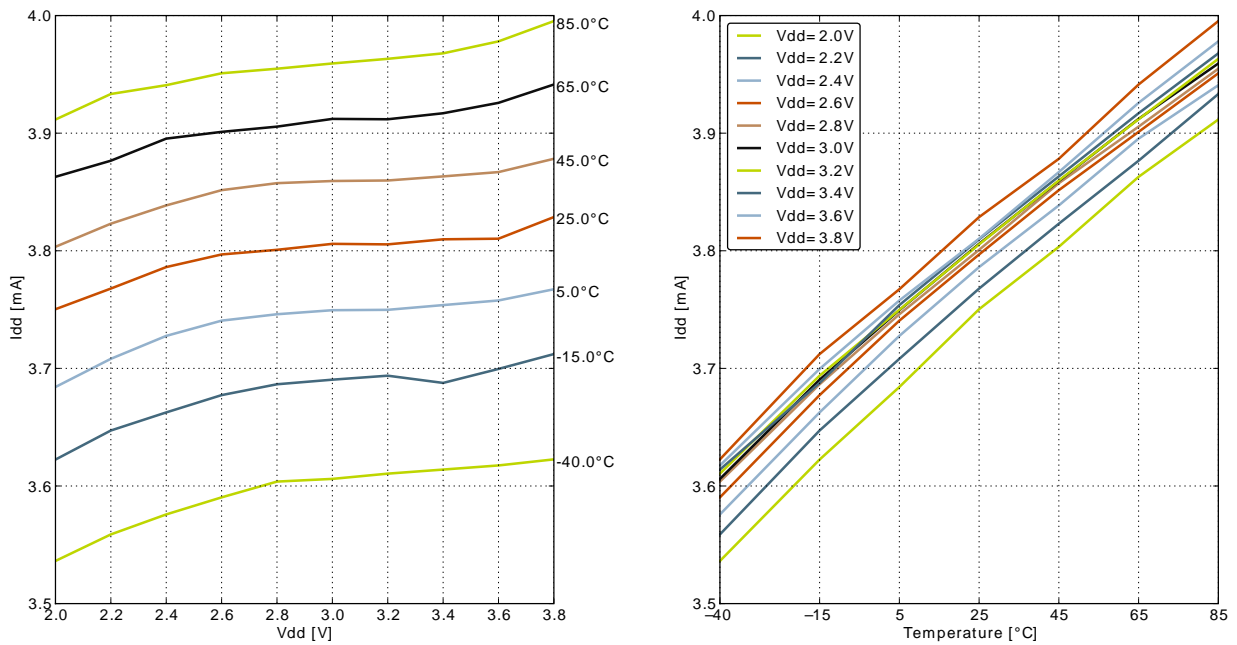

Figure 3.3. EM0 Current consumption while executing prime number calculation code from flash with HFRCO running at 14MHz

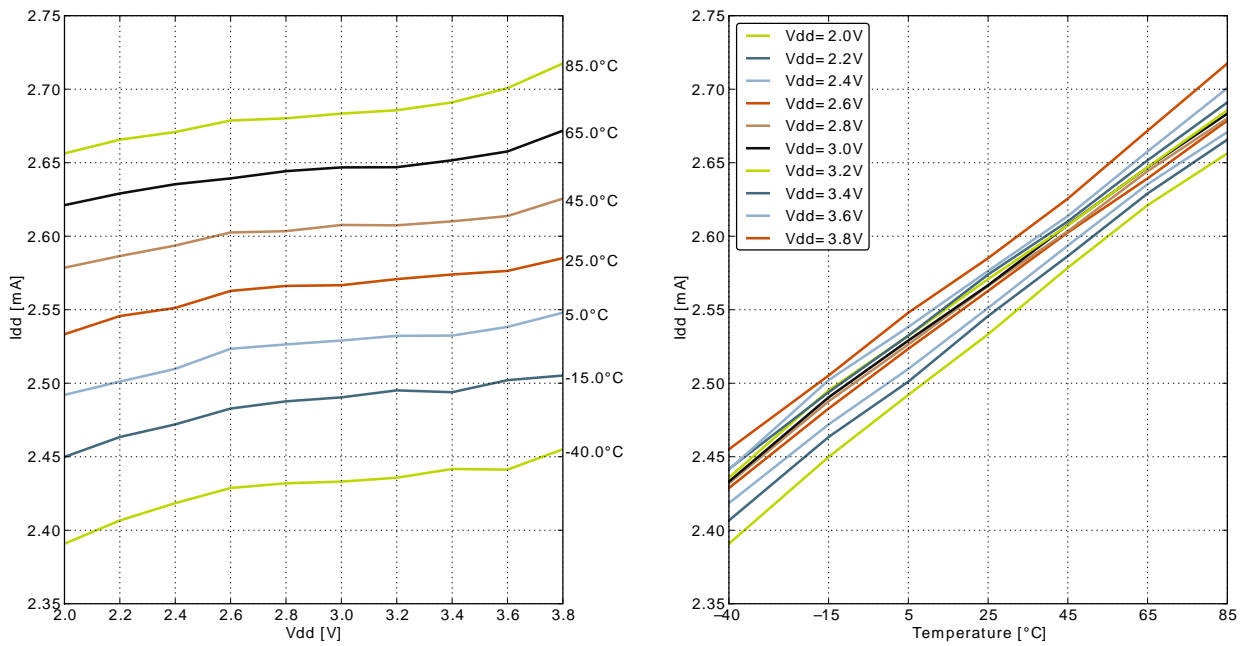

Figure 3.4. EM0 Current consumption while executing prime number calculation code from flash with HFRCO running at 11MHz

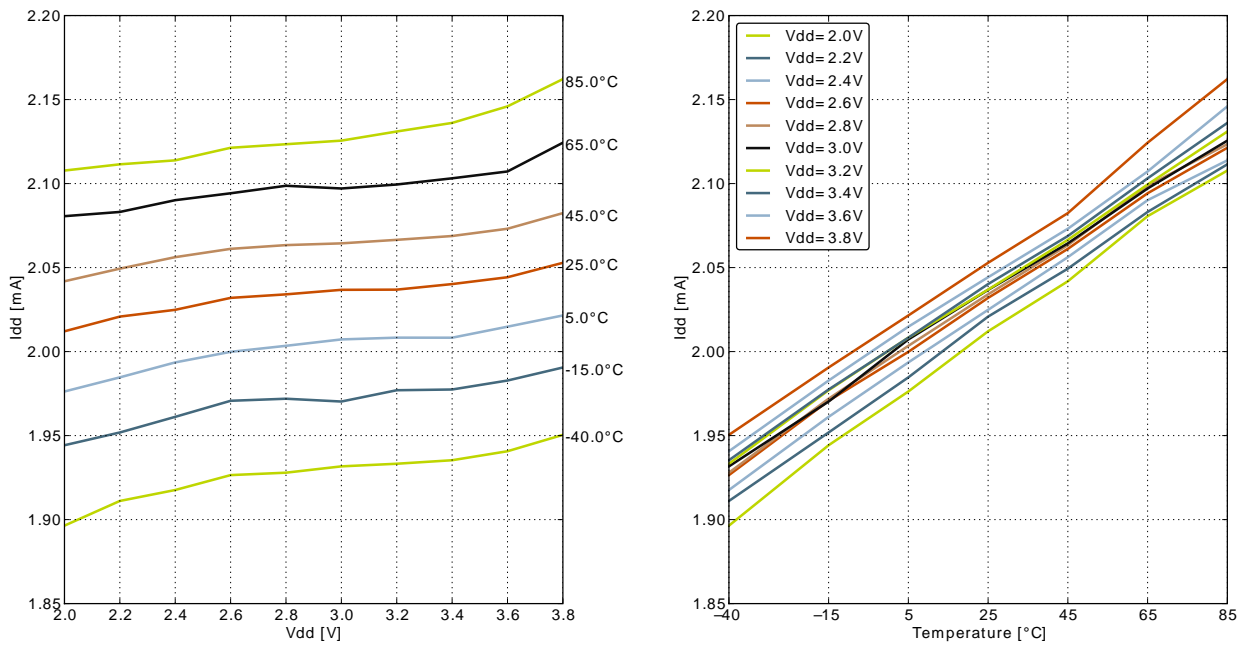

Figure 3.5. EM0 Current consumption while executing prime number calculation code from flash with HFRCO running at 7MHz

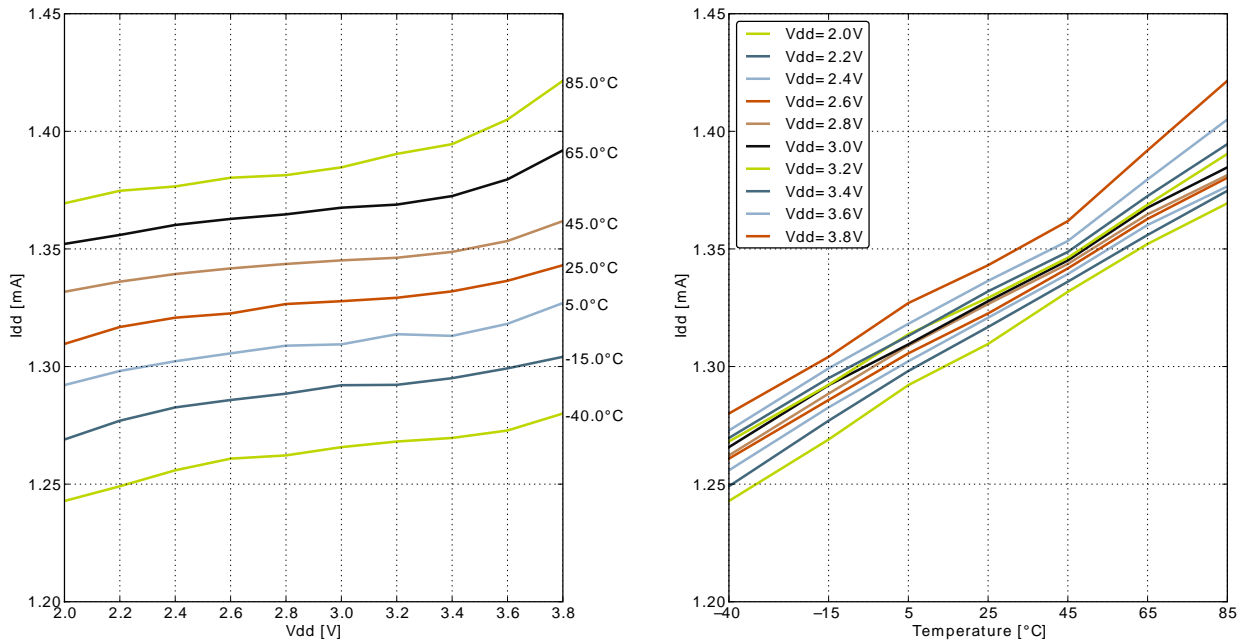

Figure 3.6. EM1 Current consumption with all peripheral clocks disabled and HFRCO running at 28MHz

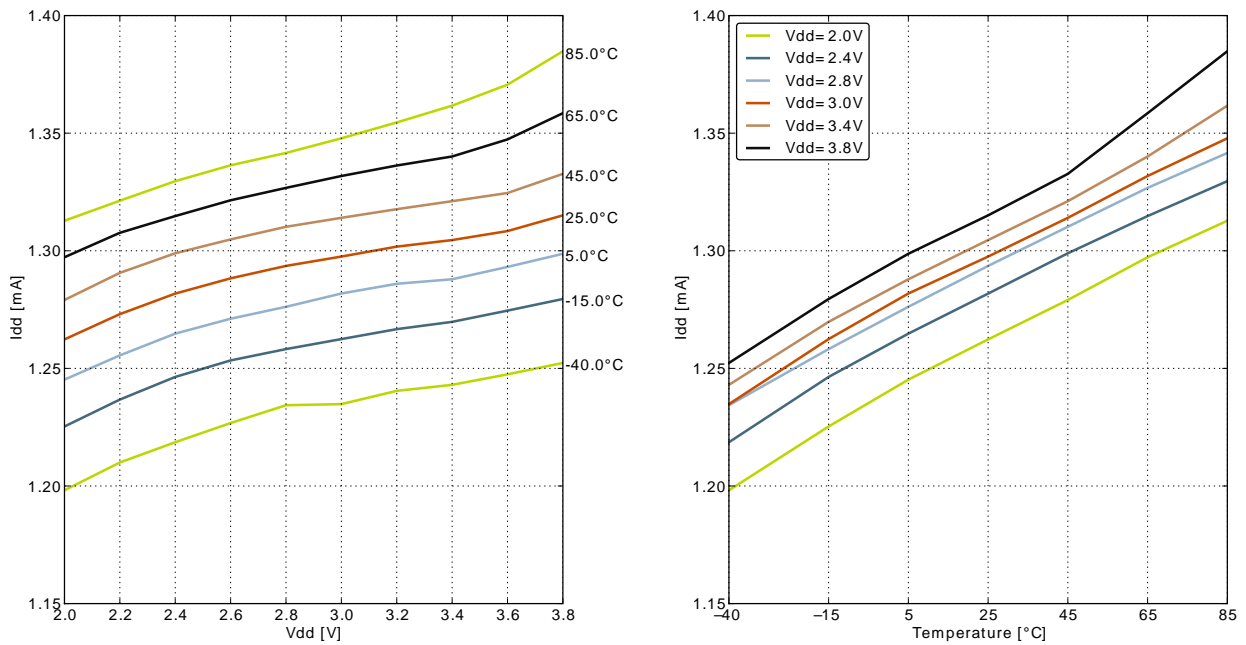

Figure 3.7. EM1 Current consumption with all peripheral clocks disabled and HFRCO running at 21MHz

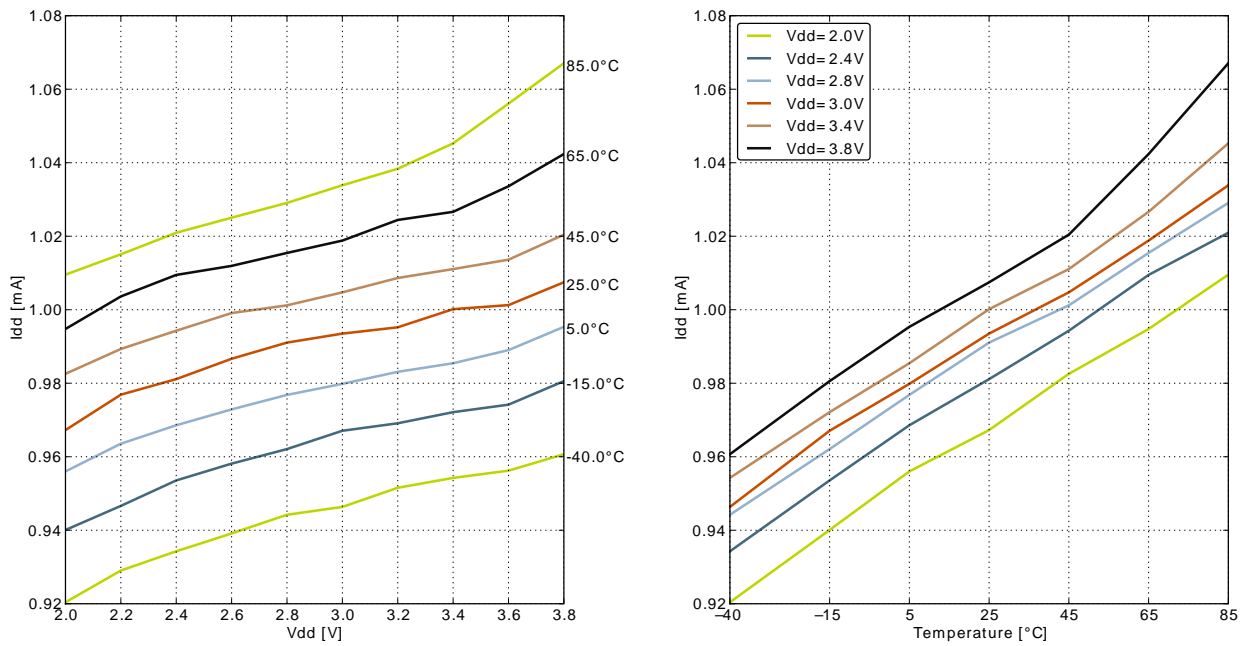

Figure 3.8. EM1 Current consumption with all peripheral clocks disabled and HFRCO running at 14MHz

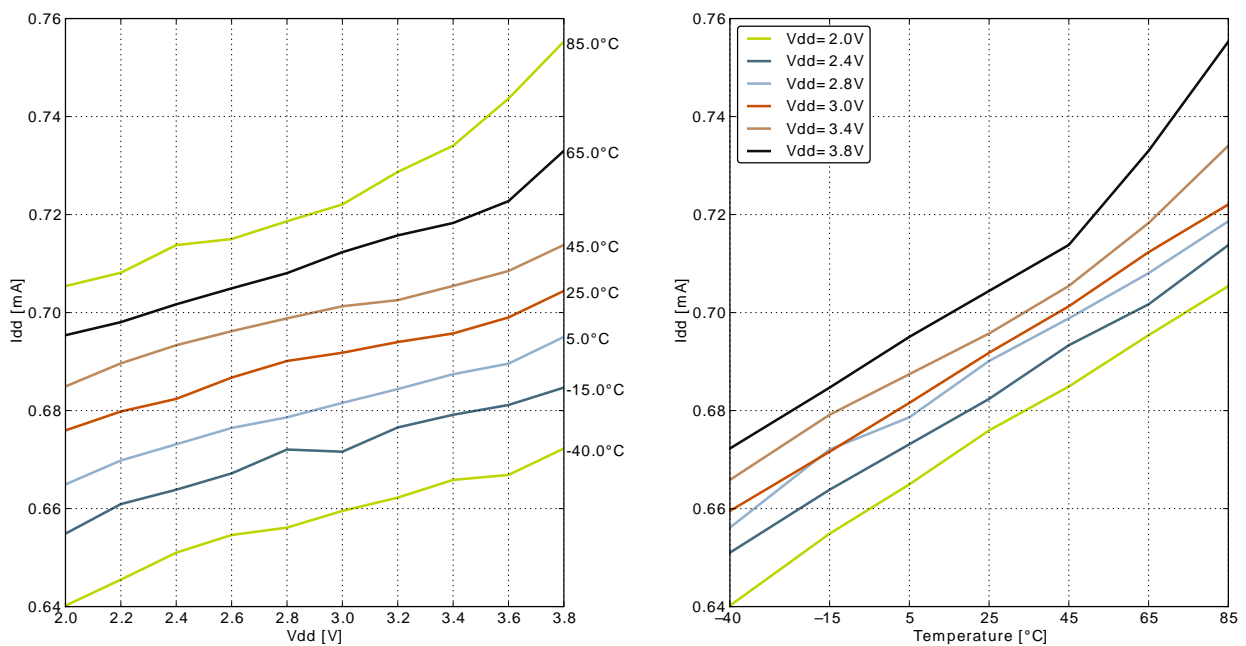

Figure 3.9. EM1 Current consumption with all peripheral clocks disabled and HFRCO running at 11MHz

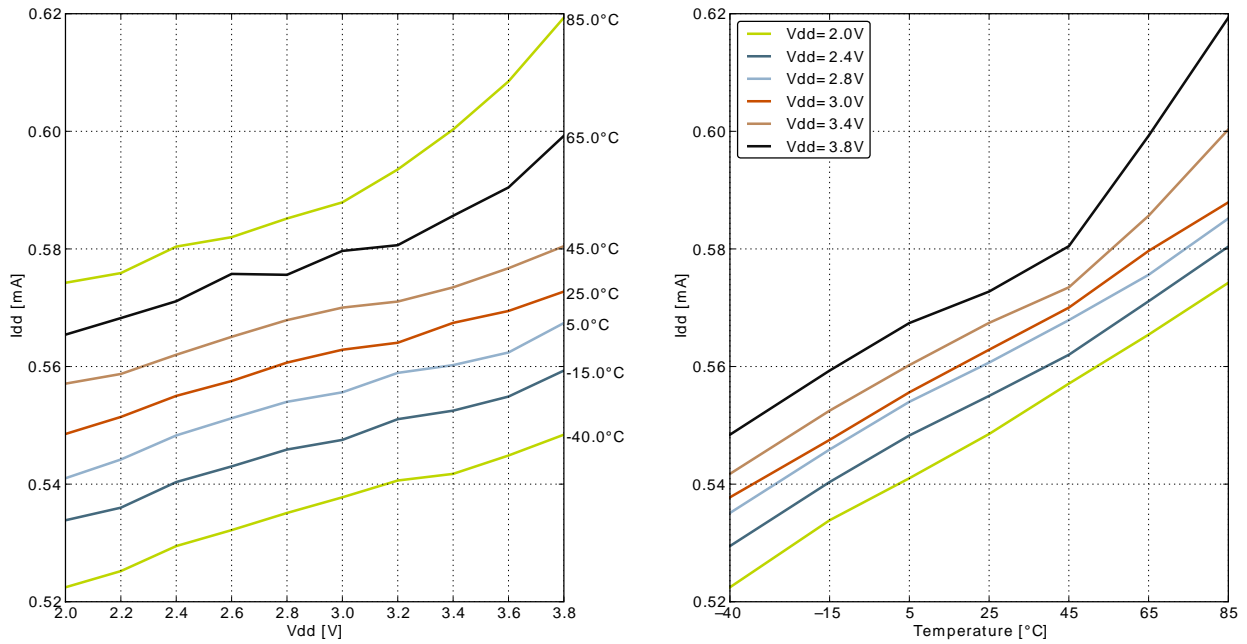

Figure 3.10. EM1 Current consumption with all peripheral clocks disabled and HFRCO running at 7MHz

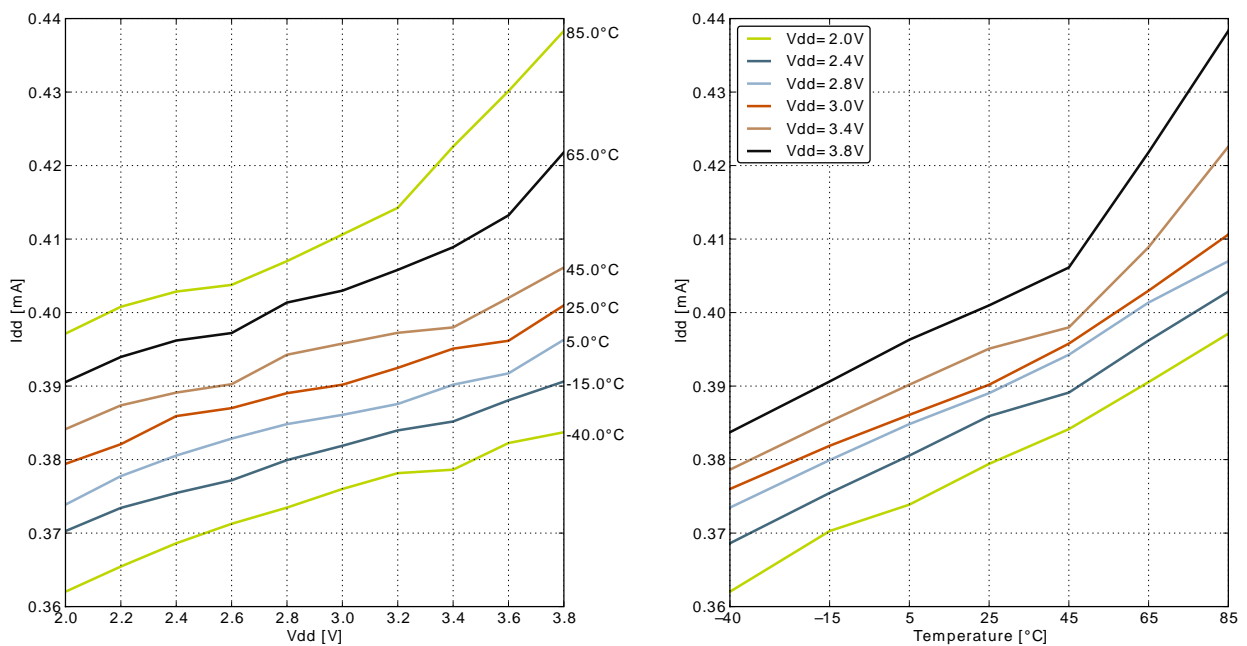

Figure 3.11. EM2 current consumption. RTC prescaled to 1kHz, 32 kHz LFRCO.

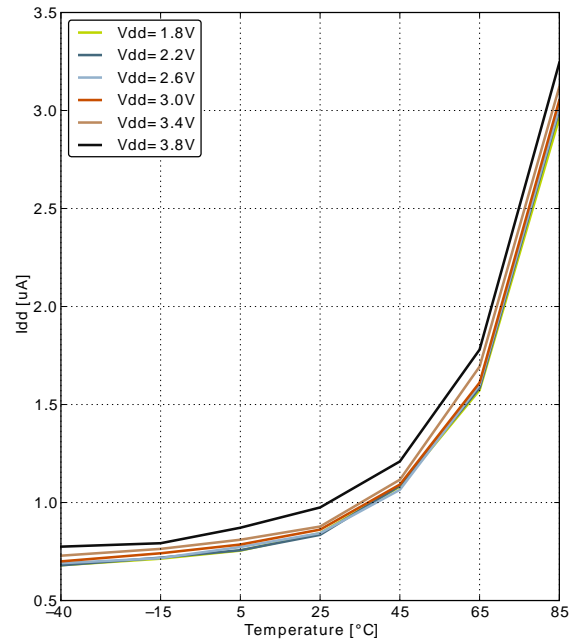
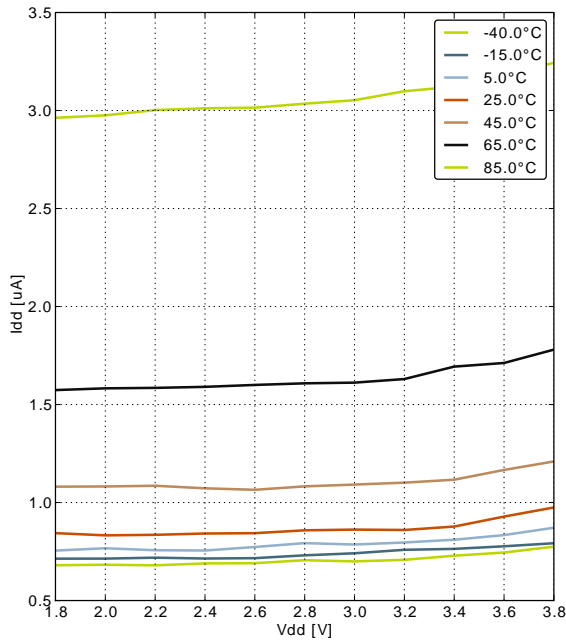

Figure 3.12. EM3 current consumption.

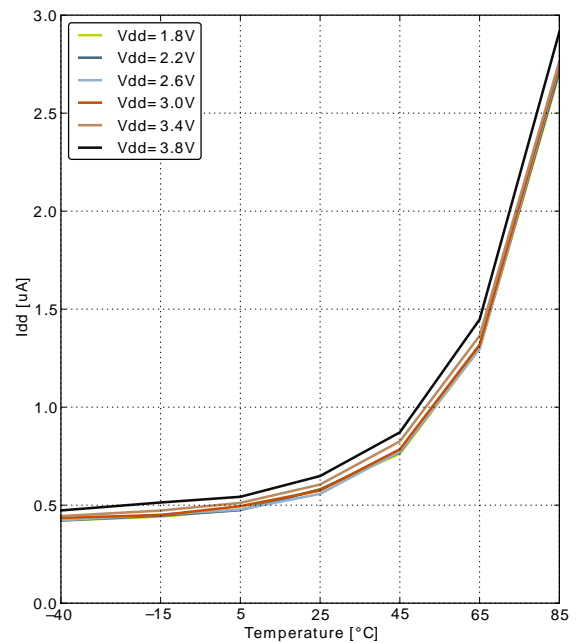
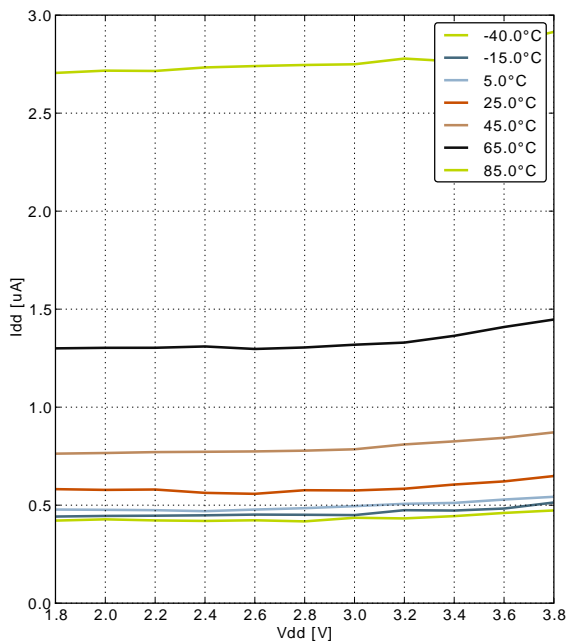
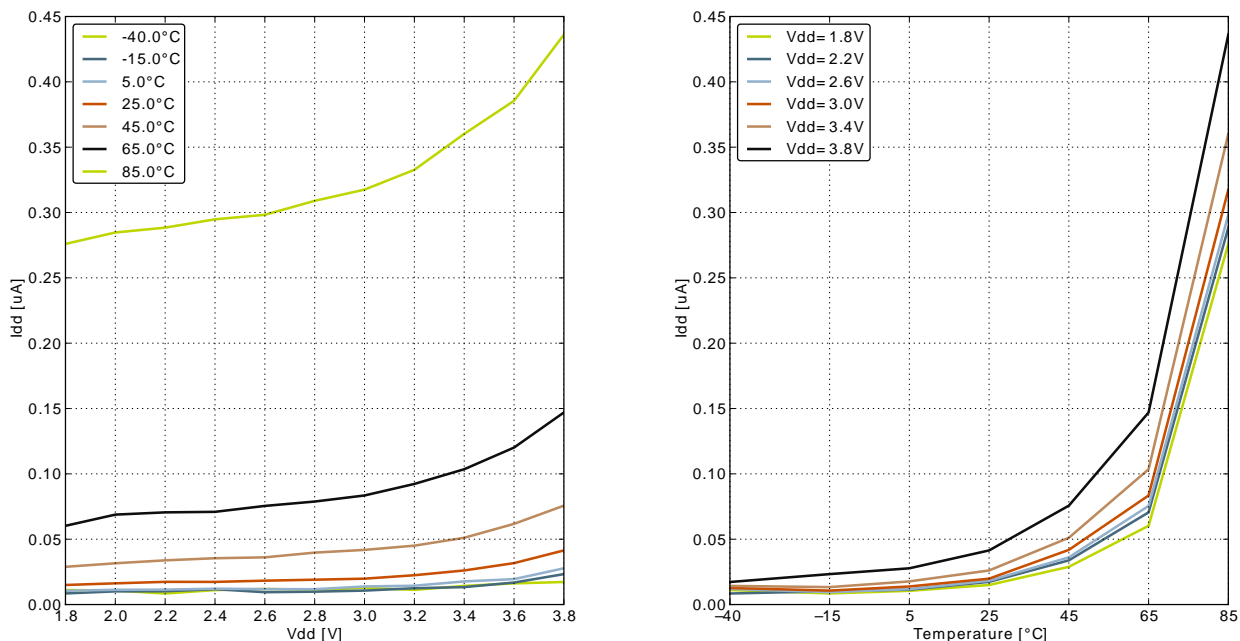

Figure 3.13. EM4 current consumption.



3.5 Transition between Energy Modes

Table 3.5. Energy Modes Transitions

Symbol	Parameter	Min	Typ	Max	Unit
t_{EM10}	Transition time from EM1 to EM0		0 ¹		HF core CLK cycles
t_{EM20}	Transition time from EM2 to EM0		2		μs
t_{EM30}	Transition time from EM3 to EM0		2		μs
t_{EM40}	Transition time from EM4 to EM0		163		μs

¹Core wakeup time only.

3.6 Power Management

This EFM32G device requires the power to be applied to the AVDD_x pins before or at the same time as power is applied to the VDD_DREG and IOVDD_x pins. In addition, it is also a requirement that all the power pins are powered with the same voltage level. For practical schematic recommendations to fulfil this requirement, please see the application note, "AN0002 EFM32 Hardware Design Considerations".

Table 3.6. Power Management

Symbol	Parameter	Condition	Min	Typ	Max	Unit
V _{BODextthr-}	BOD threshold on falling external supply voltage		1.82		1.85	V
V _{BODintthr-}	BOD threshold on falling internally regulated supply voltage		1.62		1.68	V
V _{BODextthr+}	BOD threshold on rising external supply voltage			1.85		V
V _{PORthr+}	Power-on Reset (POR) threshold on rising external supply voltage				1.98	V
t _{RESETdy}	Delay from reset is released until program execution starts	Applies to Power-on Reset, Brown-out Reset and pin reset.		163		μs
t _{RESET}	negative pulse length to ensure complete reset of device		50			ns
C _{DECOUPLE}	Voltage regulator decoupling capacitor.	X5R capacitor recommended. Apply between DECOUPLE pin and GROUND		1		μF

3.7 Flash

Table 3.7. Flash

Symbol	Parameter	Condition	Min	Typ	Max	Unit
EC _{FLASH}	Flash erase cycles before failure		20000			cycles
RET _{FLASH}	Flash data retention	T _{AMB} <150°C	10000			h
		T _{AMB} <85°C	10			years
		T _{AMB} <70°C	20			years
t _{W_PROG}	Word (32-bit) programming time		20			μs
t _{P_ERASE}	Page erase time		20	20.4	20.8	ms
t _{D_ERASE}	Device erase time		40	40.8	41.6	ms
I _{ERASE}	Erase current				7 ¹	mA
I _{WRITE}	Write current				7 ²	mA
V _{FLASH}	Supply voltage during flash erase and write		1.8		3.8	V

¹Measured at 25°C

²Measured at 25°C

3.8 General Purpose Input Output

Table 3.8. GPIO

Symbol	Parameter	Condition	Min	Typ	Max	Unit
V _{IOIL}	Input low voltage				0.3V _{DD}	V
V _{IOIH}	Input high voltage		0.7V _{DD}			V
V _{IOOH}	Output high voltage	Sourcing 6 mA, V _{DD} =1.8V, GPIO_Px_CTRL DRIVE-MODE = STANDARD	0.75V _{DD}			V
		Sourcing 6 mA, V _{DD} =3.0V, GPIO_Px_CTRL DRIVE-MODE = STANDARD	0.95V _{DD}			V
		Sourcing 20 mA, V _{DD} =1.8V, GPIO_Px_CTRL DRIVE-MODE = HIGH	0.7V _{DD}			V
		Sourcing 20 mA, V _{DD} =3.0V, GPIO_Px_CTRL DRIVE-MODE = HIGH	0.9V _{DD}			V
V _{IOOL}	Output low voltage	Sinking 6 mA, V _{DD} =1.8V, GPIO_Px_CTRL DRIVE-MODE = STANDARD			0.25V _{DD}	V
		Sinking 6 mA, V _{DD} =3.0V, GPIO_Px_CTRL DRIVE-MODE = STANDARD			0.05V _{DD}	V
		Sinking 20 mA, V _{DD} =1.8V, GPIO_Px_CTRL DRIVE-MODE = HIGH			0.3V _{DD}	V
		Sinking 20 mA, V _{DD} =3.0V, GPIO_Px_CTRL DRIVE-MODE = HIGH			0.1V _{DD}	V
I _{IOLEAK}	Input leakage current	High Impedance IO connected to GROUND or V _{DD}			+/-25	nA
R _{PU}	I/O pin pull-up resistor			40		kOhm
R _{PD}	I/O pin pull-down resistor			40		kOhm
R _{IOESD}	Internal ESD series resistor			200		Ohm
t _{IOGLITCH}	Pulse width of pulses to be removed by the glitch suppression filter		10		50	ns
t _{IOOF}	Output fall time	0.5 mA drive strength and load capacitance C _L =12.5-25pF.	20+0.1C _L		250	ns
		2mA drive strength and load capacitance C _L =350-600pF	20+0.1C _L		250	ns
V _{IOHYST}	I/O pin hysteresis (V _{IOTHR+} - V _{IOTHR-})	V _{DD} = 1.8 - 3.8 V	0.1V _{DD}			V

Figure 3.14. Typical Low-Level Output Current, 2V Supply Voltage

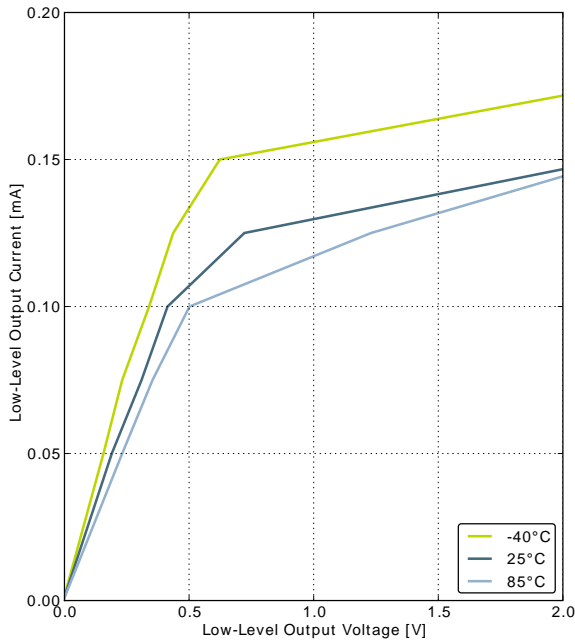

GPIO_Px_CTRL DRIVEMODE = LOWEST

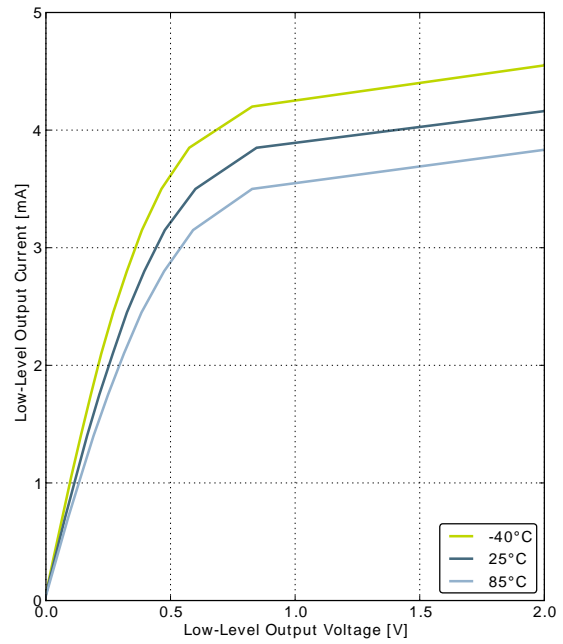

GPIO_Px_CTRL DRIVEMODE = LOW

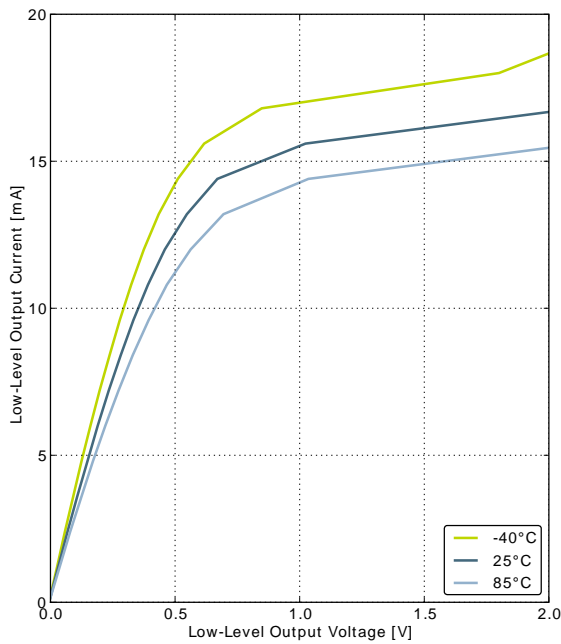

GPIO_Px_CTRL DRIVEMODE = STANDARD

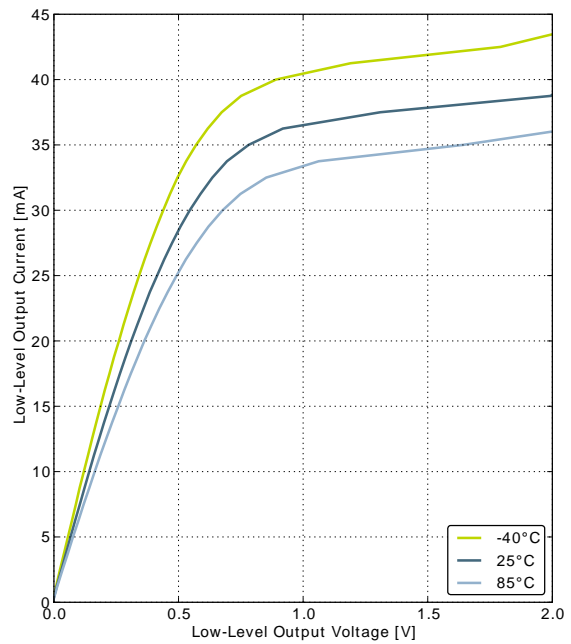

GPIO_Px_CTRL DRIVEMODE = HIGH

Figure 3.15. Typical High-Level Output Current, 2V Supply Voltage

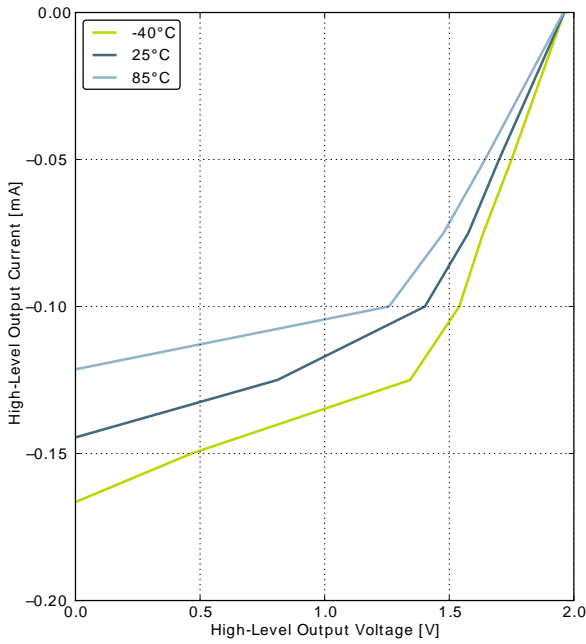

GPIO_Px_CTRL DRIVEMODE = LOWEST

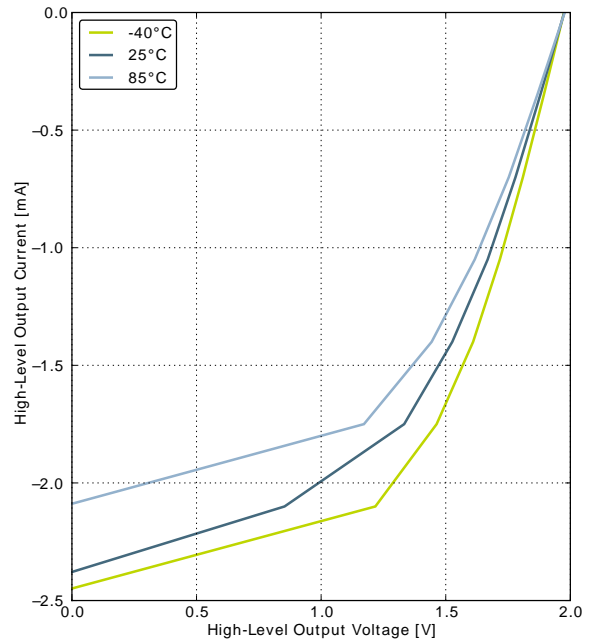

GPIO_Px_CTRL DRIVEMODE = LOW

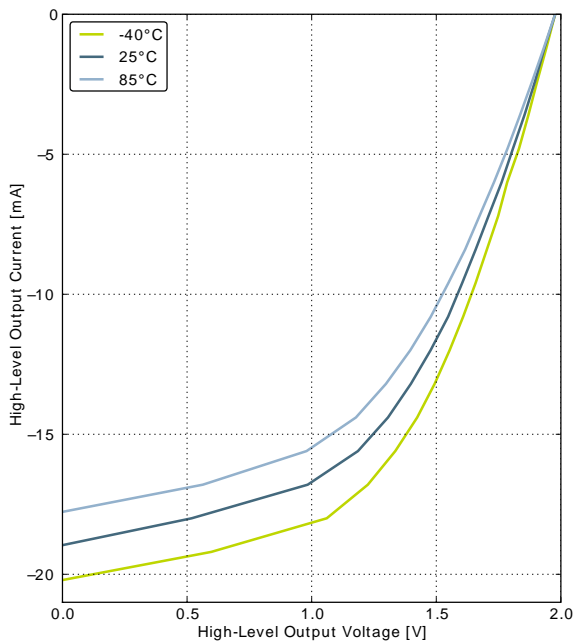

GPIO_Px_CTRL DRIVEMODE = STANDARD

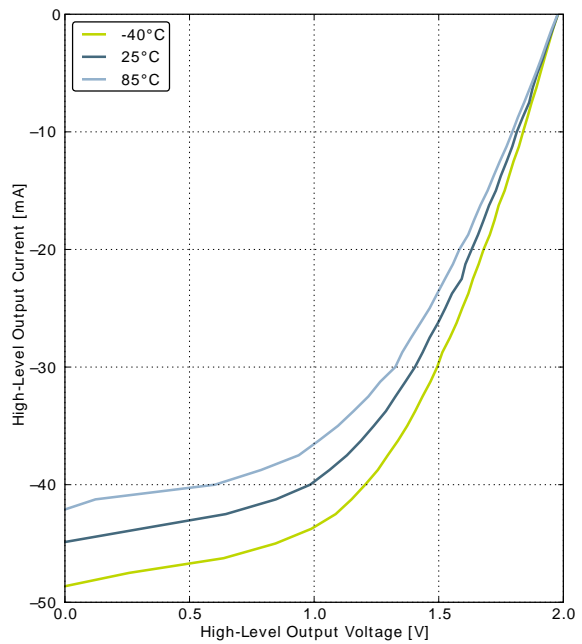

GPIO_Px_CTRL DRIVEMODE = HIGH

Figure 3.16. Typical Low-Level Output Current, 3V Supply Voltage

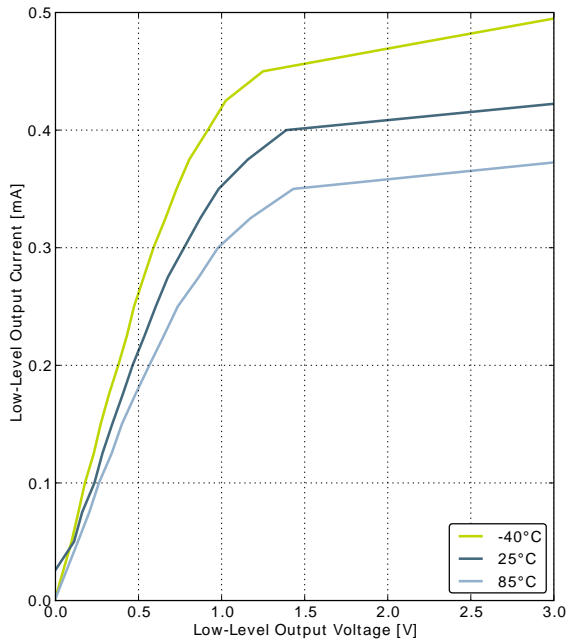

GPIO_Px_CTRL DRIVEMODE = LOWEST

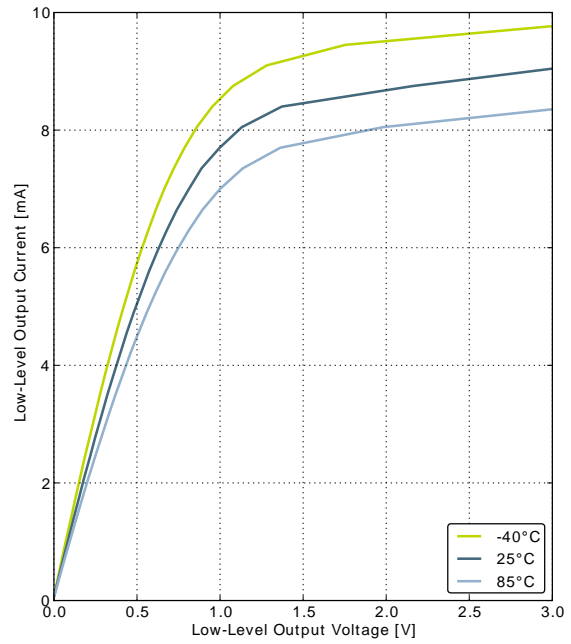

GPIO_Px_CTRL DRIVEMODE = LOW

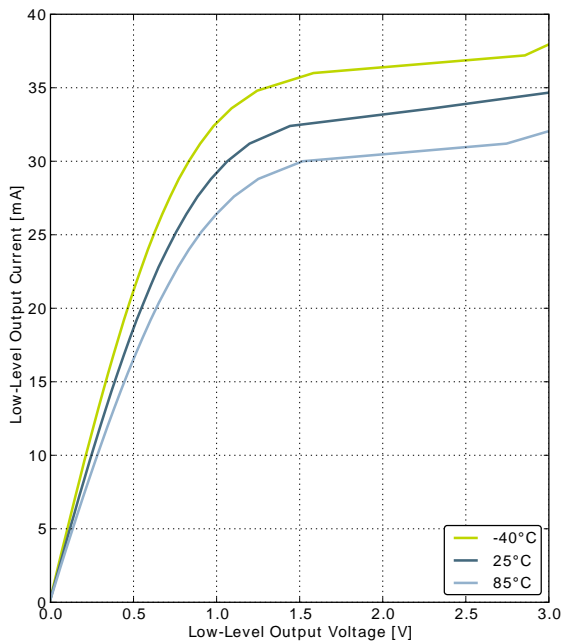

GPIO_Px_CTRL DRIVEMODE = STANDARD

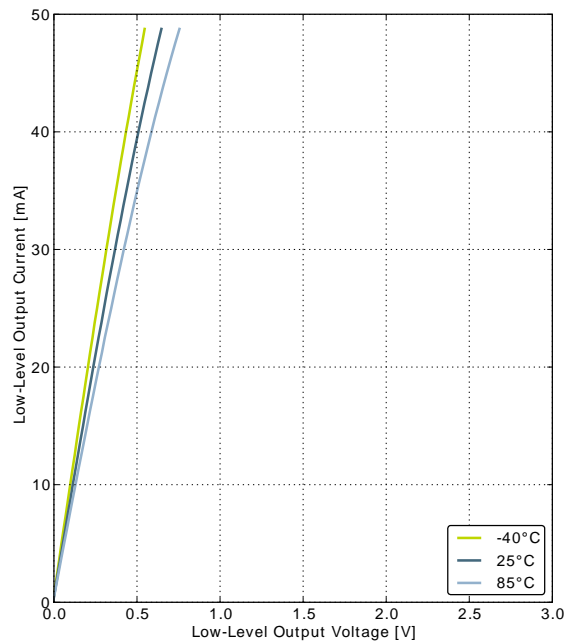

GPIO_Px_CTRL DRIVEMODE = HIGH

Figure 3.17. Typical High-Level Output Current, 3V Supply Voltage

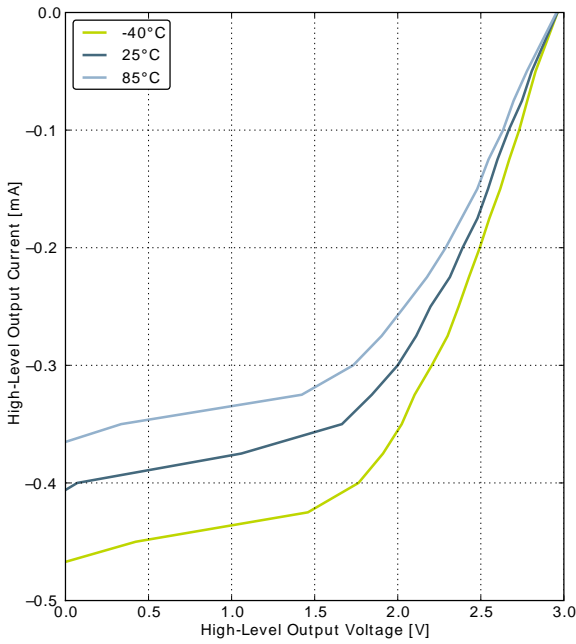

GPIO_Px_CTRL DRIVEMODE = LOWEST

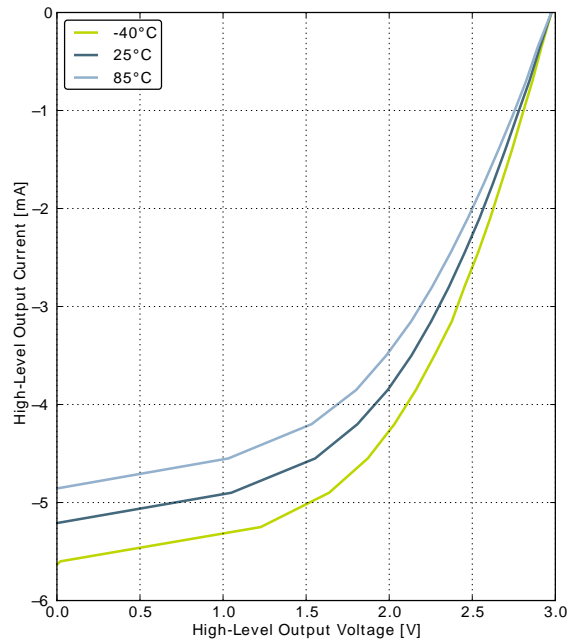

GPIO_Px_CTRL DRIVEMODE = LOW

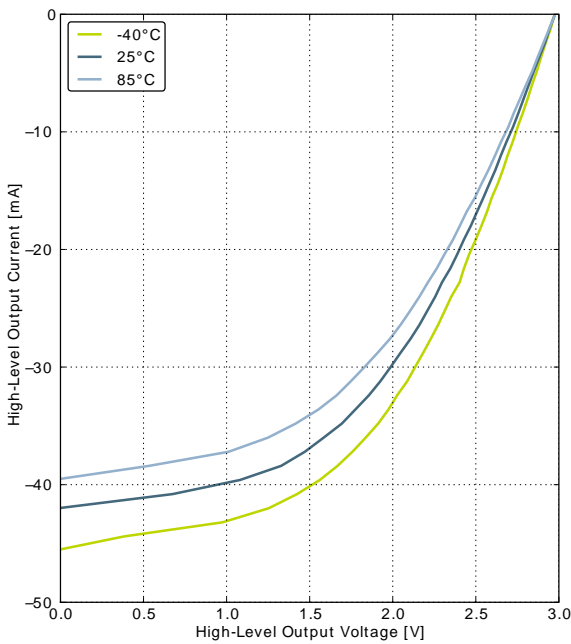

GPIO_Px_CTRL DRIVEMODE = STANDARD

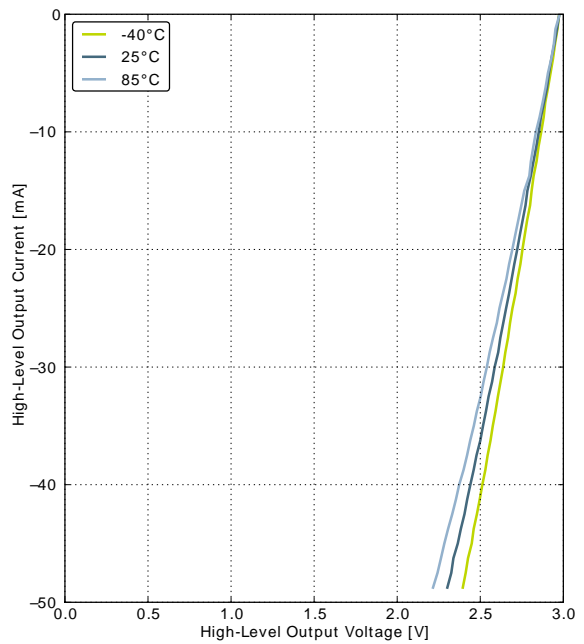

GPIO_Px_CTRL DRIVEMODE = HIGH

Figure 3.18. Typical Low-Level Output Current, 3.8V Supply Voltage

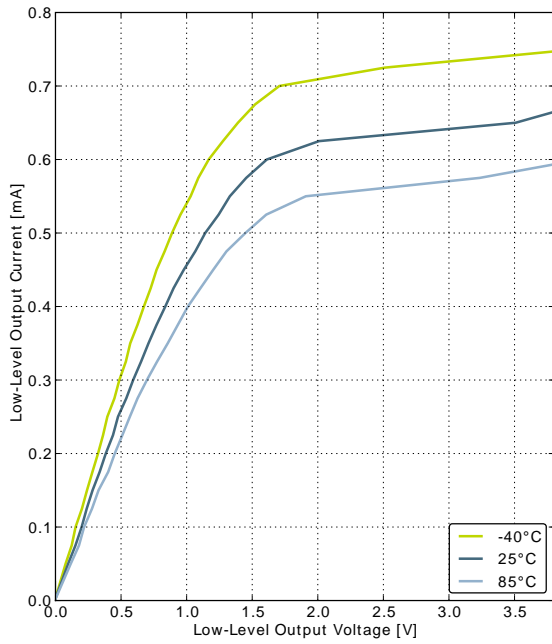

GPIO_Px_CTRL DRIVEMODE = LOWEST

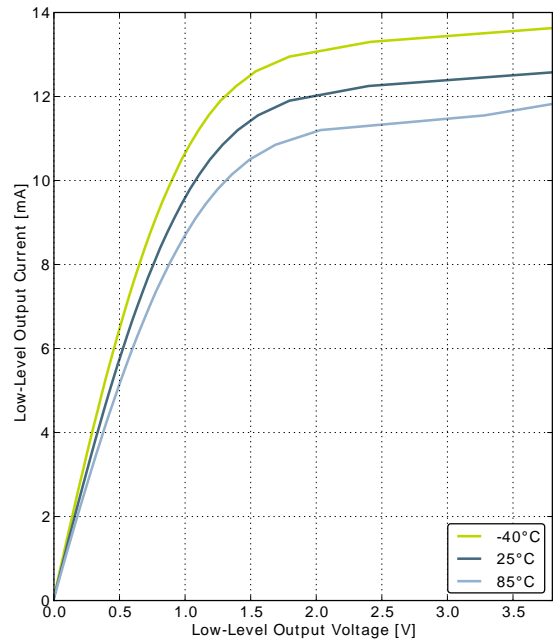

GPIO_Px_CTRL DRIVEMODE = LOW

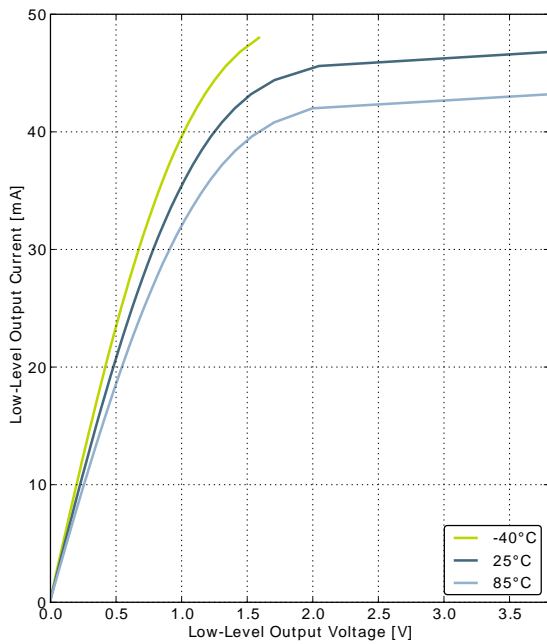

GPIO_Px_CTRL DRIVEMODE = STANDARD

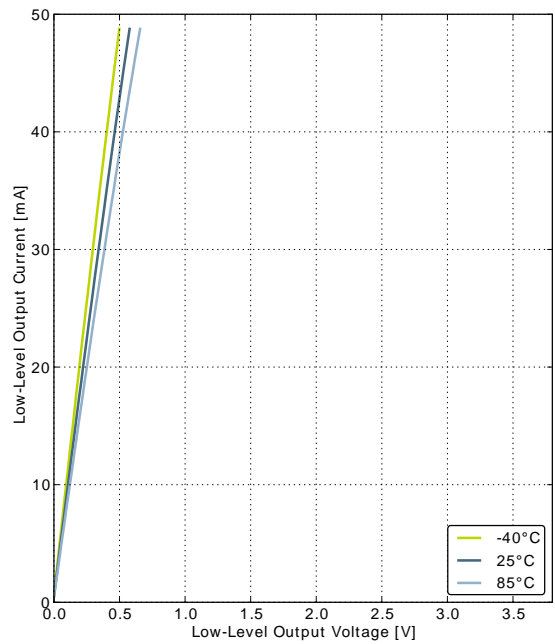

GPIO_Px_CTRL DRIVEMODE = HIGH

Figure 3.19. Typical High-Level Output Current, 3.8V Supply Voltage

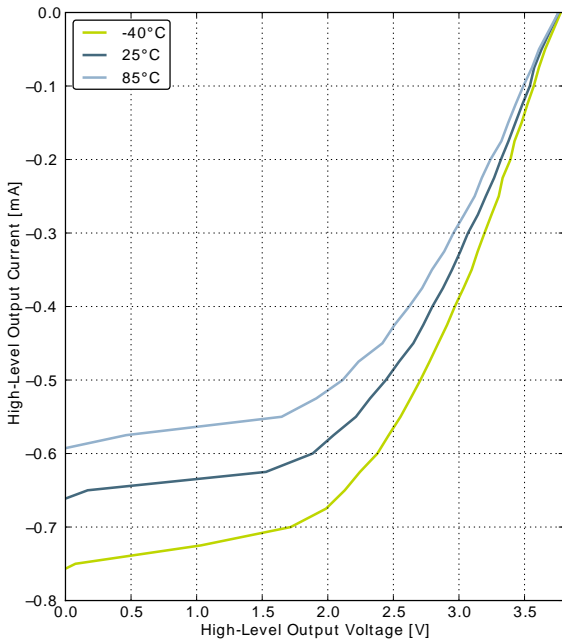

GPIO_Px_CTRL DRIVEMODE = LOWEST

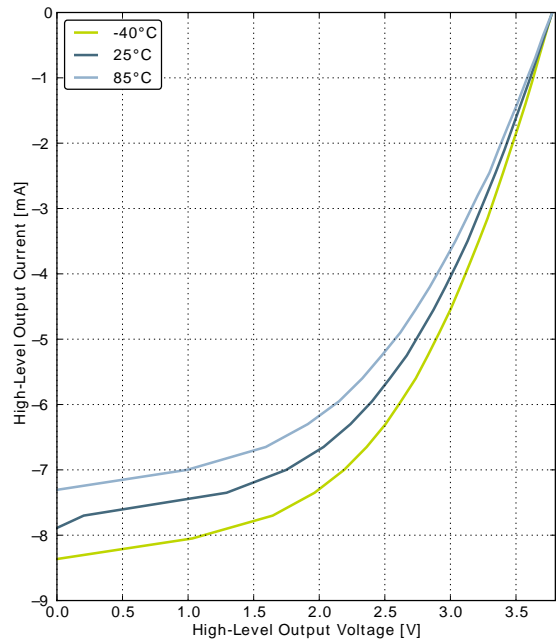

GPIO_Px_CTRL DRIVEMODE = LOW

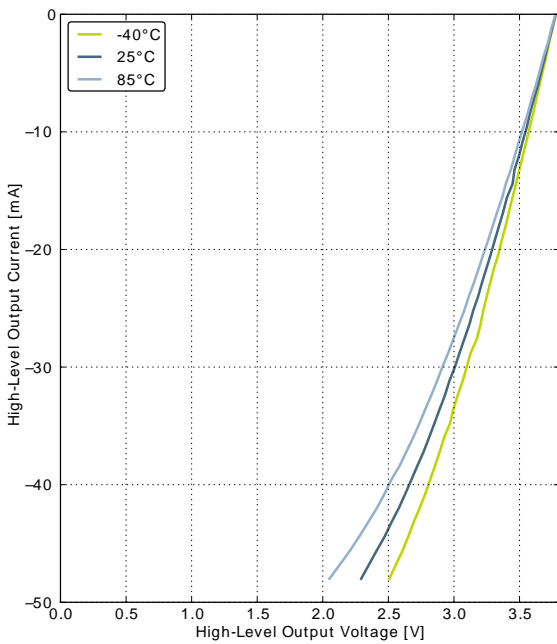

GPIO_Px_CTRL DRIVEMODE = STANDARD

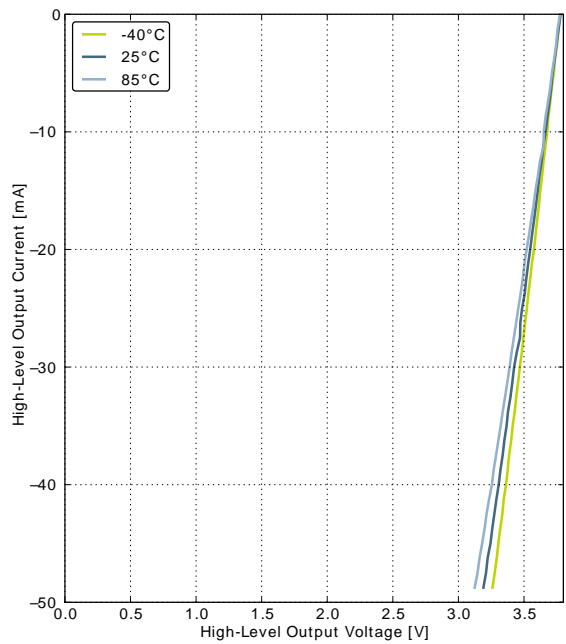

GPIO_Px_CTRL DRIVEMODE = HIGH

3.9 Oscillators

3.9.1 LFXO

Table 3.9. LFXO

Symbol	Parameter	Condition	Min	Typ	Max	Unit
f_{LFXO}	Supported nominal crystal frequency			32.768		kHz
ESR_{LFXO}	Supported crystal equivalent series resistance (ESR)			30	120	kOhm
C_{LFXOL}	Supported crystal external load range		X^1		25	pF
DC_{LFXO}	Duty cycle		48	50	53.5	%
I_{LFXO}	Current consumption for core and buffer after start-up.	ESR=30 kOhm, $C_L=10$ pF, LFXOBOOST in CMU_CTRL is 1		190		nA
t_{LFXO}	Start- up time.	ESR=30 kOhm, $C_L=10$ pF, 40% - 60% duty cycle has been reached, LFXOBOOST in CMU_CTRL is 1		400		ms

¹See Minimum Load Capacitance (C_{LFXOL}) Requirement For Safe Crystal Startup figure and table

For safe startup of a given crystal, the load capacitance should be larger than the value indicated in Figure 3.20 (p. 27) and in Table 3.10 (p. 27) for a given LFXOBOOST setting. The minimum supported load capacitance depends on the crystal shunt capacitance, C_0 , which is specified in crystal vendors' datasheet.

Figure 3.20. Minimum Load Capacitance (C_{LFXOL}) Requirement For Safe Crystal Startup

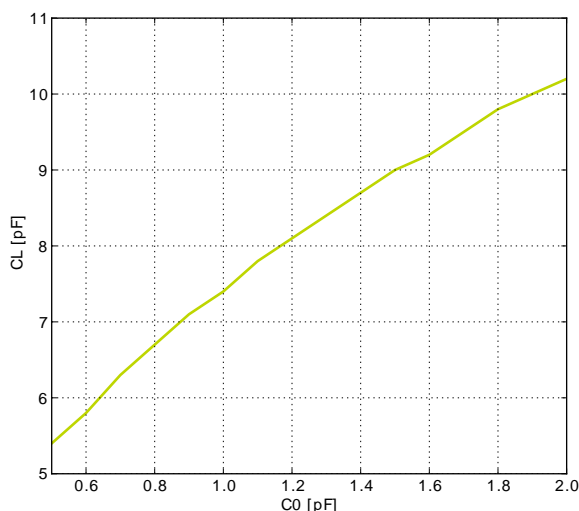

Table 3.10. Minimum Load Capacitance (C_{LFXOL}) Requirement For Safe Crystal Startup

Symbol	Capacitance [pF]															
	0.5	0.6	0.7	0.8	0.9	1.0	1.1	1.2	1.3	1.4	1.5	1.6	1.7	1.8	1.9	2.0
Shunt Capacitance C_0	0.5	0.6	0.7	0.8	0.9	1.0	1.1	1.2	1.3	1.4	1.5	1.6	1.7	1.8	1.9	2.0
$C_{L_{min}}$ lfxoboost = 0	5.4	5.8	6.3	6.7	7.1	7.4	7.8	8.1	8.4	8.7	9.0	9.2	9.5	9.8	10.0	10.2

3.9.2 HFXO

Table 3.11. HFXO

Symbol	Parameter	Condition	Min	Typ	Max	Unit
f_{HFXO}	Supported nominal crystal Frequency		4		32	MHz
ESR_{HFXO}	Supported crystal equivalent series resistance (ESR)	Crystal frequency 32 MHz		30	60	Ohm
		Crystal frequency 4 MHz		400	1500	Ohm
g_{mHFXO}	The transconductance of the HFXO input transistor at crystal startup	HFXOBOOST in CMU_CTRL equals 0b11	20			mS
C_{HFXOL}	Supported crystal external load range		5		25	pF
DC_{HFXO}	Duty cycle		46	50	54	%
I_{HFXO}	Current consumption for HFXO after startup	4 MHz: ESR=400 Ohm, $C_L=20$ pF, HFXOBOOST in CMU_CTRL equals 0b11		85		μA
		32 MHz: ESR=30 Ohm, $C_L=10$ pF, HFXOBOOST in CMU_CTRL equals 0b11		165		μA
t_{HFXO}	Startup time	32 MHz: ESR=30 Ohm, $C_L=10$ pF, HFXOBOOST in CMU_CTRL equals 0b11		400		μs
	Pulse width removed by glitch detector		1		4	ns

3.9.3 LFRCO

Table 3.12. LFRCO

Symbol	Parameter	Condition	Min	Typ	Max	Unit
f_{LFRCO}	Oscillation frequency , $V_{\text{DD}}=3.0$ V, $T_{\text{AMB}}=25^\circ\text{C}$			32		kHz
t_{LFRCO}	Startup time not including software calibration			150		μs
I_{LFRCO}	Current consumption			190		nA
TC_{LFRCO}	Temperature coefficient			± 0.02		%/ $^\circ\text{C}$
VC_{LFRCO}	Supply voltage coefficient			± 15		%/V
$\text{TUNESTEP}_{\text{LFRCO}}$	Frequency step for LSB change in TUNING value			1.5		%

Figure 3.21. Calibrated LFRCO Frequency vs Temperature and Supply Voltage

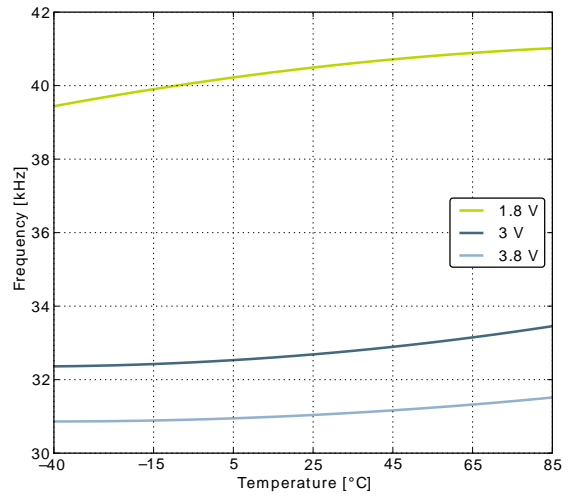
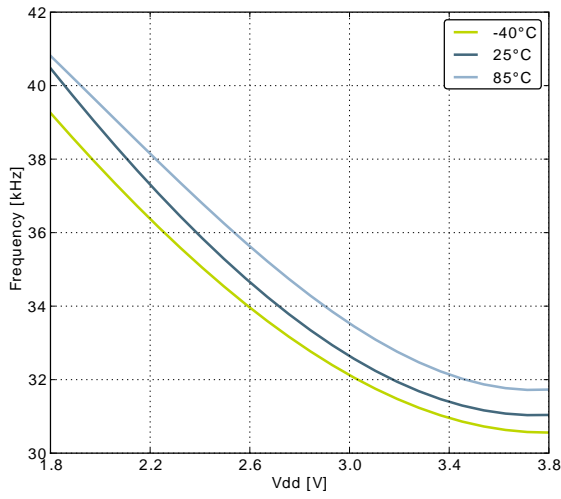

3.9.4 HFRCO

Table 3.13. HFRCO

Symbol	Parameter	Condition	Min	Typ	Max	Unit
f _{HFRCO}	Oscillation frequency, V _{DD} =3.0 V, T _{AMB} =25°C	28 MHz frequency band		28		MHz
		21 MHz frequency band		21		MHz
		14 MHz frequency band		14		MHz
		11 MHz frequency band		11		MHz
		7 MHz frequency band		7		MHz
		1 MHz frequency band		1		MHz
t _{HFRCO_settling}	Settling time after start-up	f _{HFRCO} = 14 MHz		0.6		Cycles
I _{HFRCO}	Current consumption	f _{HFRCO} = 28 MHz		106		µA
		f _{HFRCO} = 21 MHz		93		µA
		f _{HFRCO} = 14 MHz		77		µA
		f _{HFRCO} = 11 MHz		72		µA
		f _{HFRCO} = 7 MHz		63		µA
		f _{HFRCO} = 1 MHz		22		µA
DC _{HFRCO}	Duty cycle	f _{HFRCO} = 14 MHz	48.5	50	51	%
TC _{HFRCO}	Temperature coefficient, V _{DD} = 3.0 V	f _{HFRCO} = 14 MHz		±0.01 ¹		%/°C
		f _{HFRCO} = 28 MHz		±0.005 ¹		%/°C
		f _{HFRCO} = 21 MHz		±0.01 ¹		%/°C
		f _{HFRCO} = 11 MHz		±0.02 ¹		%/°C
		f _{HFRCO} = 7 MHz		±0.02 ¹		%/°C
		f _{HFRCO} = 1 MHz		±0.06 ¹		%/°C
VC _{HFRCO}	Supply voltage coefficient, T _{AMB} =25°C	f _{HFRCO} = 14 MHz		±0.32 ²		%/V
		f _{HFRCO} = 28 MHz		±0.52 ²		%/V
		f _{HFRCO} = 21 MHz		±0.25 ²		%/V
		f _{HFRCO} = 11 MHz		±0.28 ²		%/V
		f _{HFRCO} = 7 MHz		±0.3 ²		%/V
		f _{HFRCO} = 1 MHz		±15 ²		%/V
TUNESTEP _{H-FRCO}	Frequency step for LSB change in TUNING value			0.3		%

¹Calculated using (max(-40°C - 85°C) - min(-40°C - 85°C)) / f_{HFRCO} / (85°C - (-40°C))

²Calculated using (max(1.8V - 3.8V) - min(1.8V - 3.8V)) / f_{HFRCO} / (3.8V - 1.8V))

Figure 3.22. Calibrated HFRCO 1 MHz Band Frequency vs Temperature and Supply Voltage

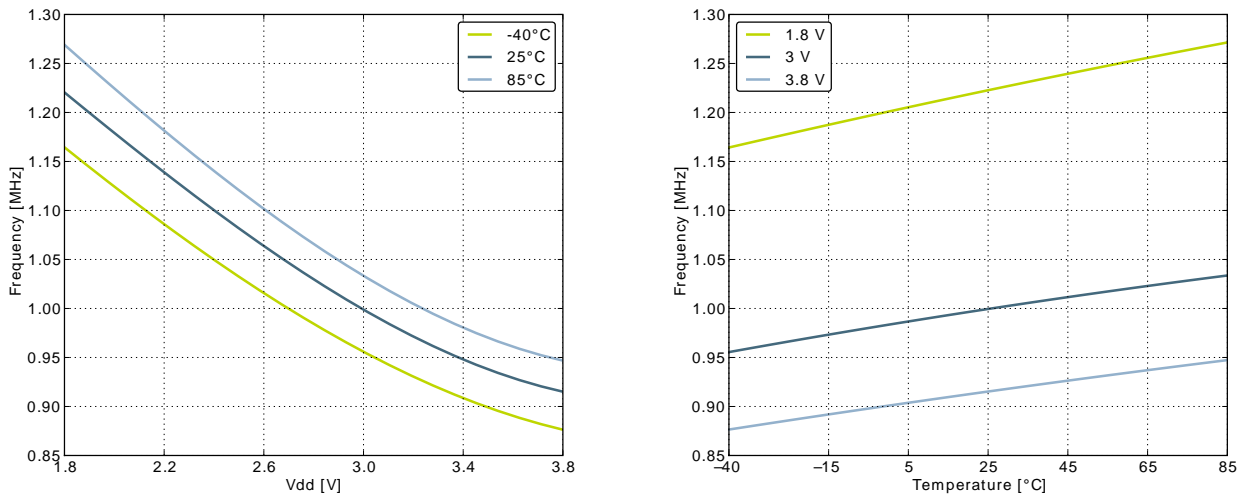

Figure 3.23. Calibrated HFRCO 7 MHz Band Frequency vs Temperature and Supply Voltage

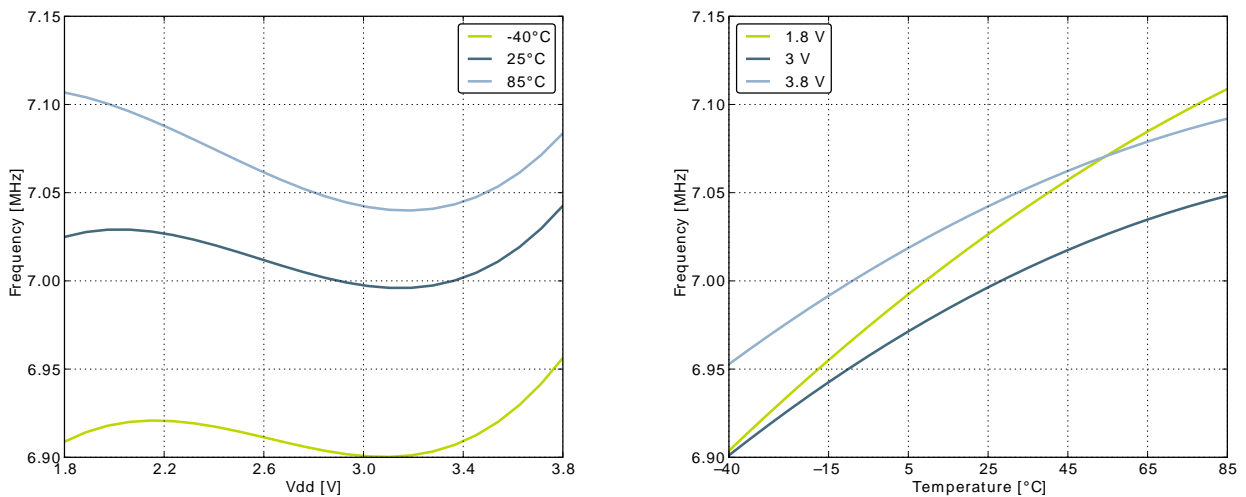

Figure 3.24. Calibrated HFRCO 11 MHz Band Frequency vs Temperature and Supply Voltage

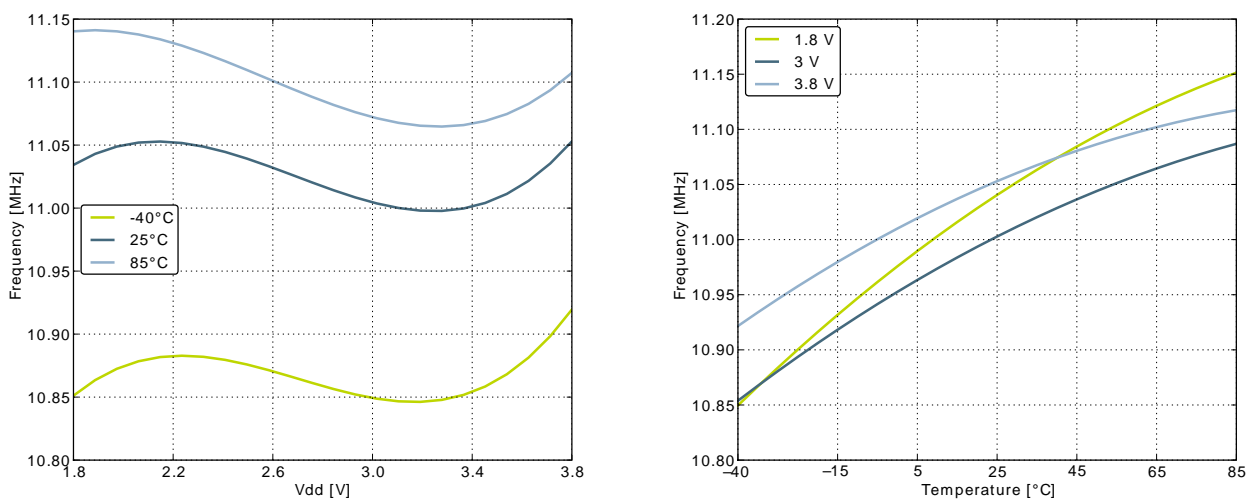

Figure 3.25. Calibrated HFRCO 14 MHz Band Frequency vs Temperature and Supply Voltage

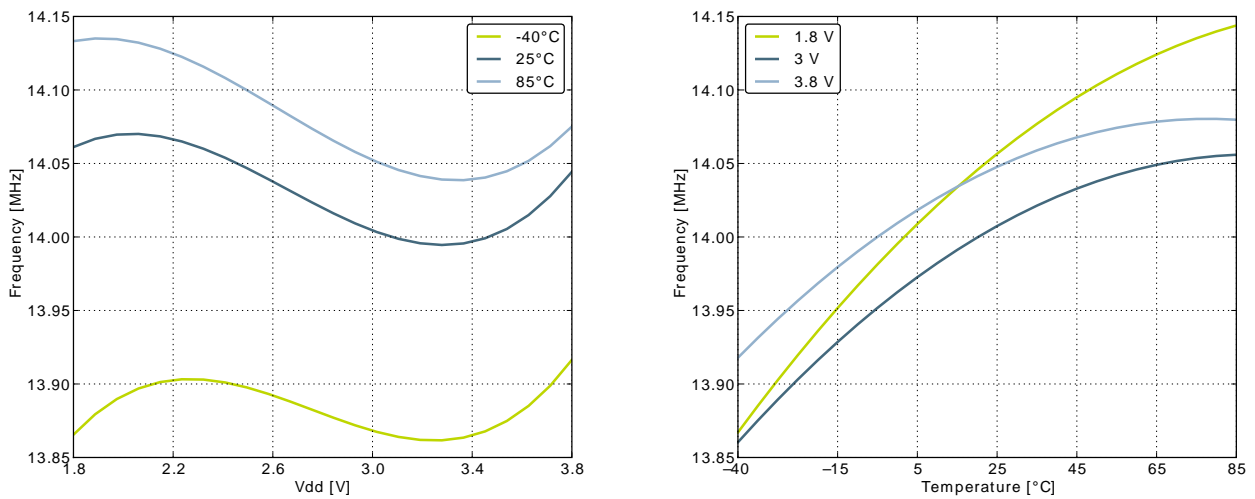

Figure 3.26. Calibrated HFRCO 21 MHz Band Frequency vs Temperature and Supply Voltage

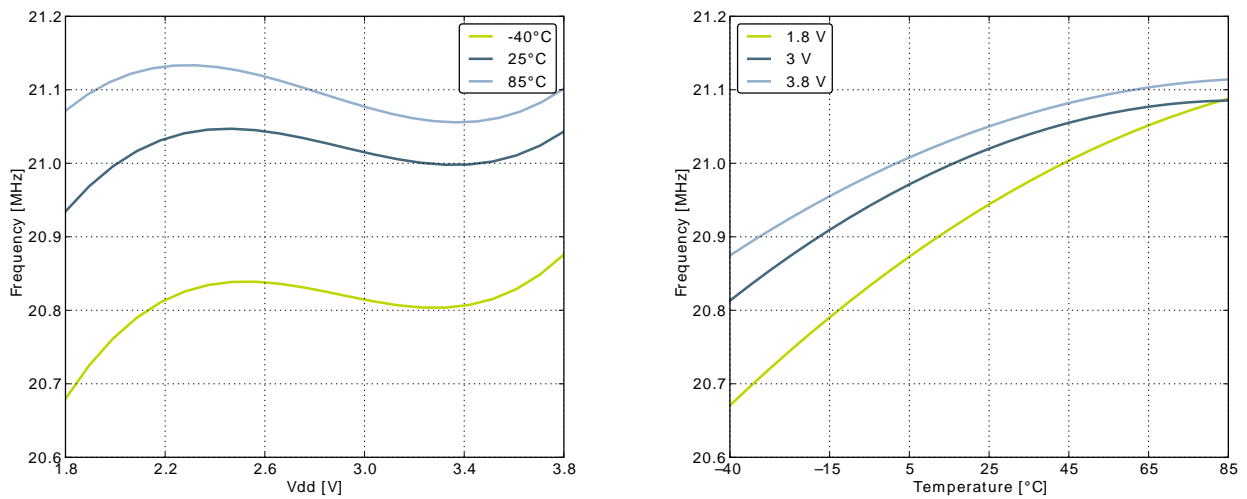
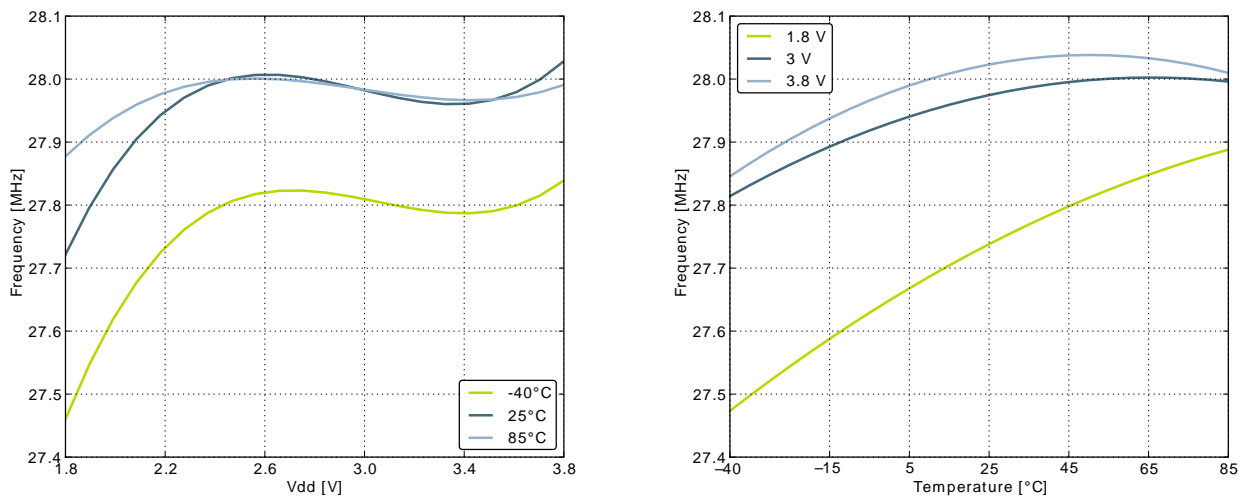

Figure 3.27. Calibrated HFRCO 28 MHz Band Frequency vs Temperature and Supply Voltage



3.9.5 ULFRCO

Table 3.14. ULFRCO

Symbol	Parameter	Condition	Min	Typ	Max	Unit
f _{ULFRCO}	Oscillation frequency	25°C, 3V	0.8		1.5	kHz
TC _{ULFRCO}	Temperature coefficient			0.05		%/°C
VC _{ULFRCO}	Supply voltage coefficient			-18.2		%/V

3.10 Analog Digital Converter (ADC)

Table 3.15. ADC

Symbol	Parameter	Condition	Min	Typ	Max	Unit
V _{ADCIN}	Input voltage range	Single ended	0		V _{REF}	V
		Differential	-V _{REF} /2		V _{REF} /2	V
V _{ADCREFIN}	Input range of external reference voltage, single ended and differential		1.25		V _{DD}	V
V _{ADCREFIN_CH7}	Input range of external negative reference voltage on channel 7	See V _{ADCREFIN}	0		V _{DD} - 1.1	V
V _{ADCREFIN_CH6}	Input range of external positive reference voltage on channel 6	See V _{ADCREFIN}	0.625		V _{DD}	V
V _{ADCCMIN}	Common mode input range		0		V _{DD}	V
I _{ADCIN}	Input current	2pF sampling capacitors		<100		nA
CMRR _{ADC}	Analog input common mode rejection ratio			65		dB
I _{ADC}	Average active current	1 MSamples/s, 12 bit, external reference		351		μA
		1 MSamples/s, 12 bit, internal reference		411		μA
		10 kSamples/s 12 bit, internal 1.25 V reference, WARMUP-MODE in ADCn_CTRL set to 0b00, ADC_CLK running at 13MHz		67		μA
		10 kSamples/s 12 bit, internal 1.25 V reference, WARMUP-MODE in ADCn_CTRL set to 0b01, ADC_CLK running at 13MHz		63		μA
		10 kSamples/s 12 bit, internal 1.25 V reference, WARMUP-MODE in ADCn_CTRL set to 0b10, ADC_CLK running at 13MHz		64		μA
C _{ADCIN}	Input capacitance			2		pF
R _{ADCIN}	Input ON resistance		1			MΩ
R _{ADCFLT}	Input RC filter resistance			10		kΩ

Symbol	Parameter	Condition	Min	Typ	Max	Unit
C _{ADCFILT}	Input RC filter/decoupling capacitance			250		fF
f _{ADCCLK}	ADC Clock Frequency				13	MHz
t _{ADCCONV}	Conversion time	6 bit		7		ADC-CLK Cycles
		10 bit		11		ADC-CLK Cycles
		12 bit		13		ADC-CLK Cycles
t _{ADCACQ}	Acquisition time	Programmable		1	256	ADC-CLK Cycles
t _{ADCACQVDD3}	Required acquisition time for VDD/3 reference			2		µs
t _{ADCSTART}	Startup time of reference generator and ADC core in NORMAL mode				5	µs
	Startup time of reference generator and ADC core in KEEPADCWARM mode				1	µs
SNR _{ADC}	Signal to Noise Ratio (SNR)	1 MSamples/s, 12 bit, single ended, internal 1.25V reference			59	dB
		1 MSamples/s, 12 bit, single ended, internal 2.5V reference			63	dB
		1 MSamples/s, 12 bit, single ended, V _{DD} reference			65	dB
		1 MSamples/s, 12 bit, differential, internal 1.25V reference			60	dB
		1 MSamples/s, 12 bit, differential, internal 2.5V reference			65	dB
		1 MSamples/s, 12 bit, differential, 5V reference			54	dB
		1 MSamples/s, 12 bit, differential, V _{DD} reference			67	dB
		1 MSamples/s, 12 bit, differential, 2xV _{DD} reference			69	dB
		200 kSamples/s, 12 bit, single ended, internal 1.25V reference			62	dB
		200 kSamples/s, 12 bit, single ended, internal 2.5V reference			63	dB
		200 kSamples/s, 12 bit, single ended, V _{DD} reference			67	dB

Symbol	Parameter	Condition	Min	Typ	Max	Unit
		200 kSamples/s, 12 bit, differential, internal 1.25V reference		63		dB
		200 kSamples/s, 12 bit, differential, internal 2.5V reference		66		dB
		200 kSamples/s, 12 bit, differential, 5V reference		66		dB
		200 kSamples/s, 12 bit, differential, V _{DD} reference		69		dB
		200 kSamples/s, 12 bit, differential, 2xV _{DD} reference		70		dB
		1 MSamples/s, 12 bit, single ended, internal 1.25V reference		58		dB
		1 MSamples/s, 12 bit, single ended, internal 2.5V reference		62		dB
		1 MSamples/s, 12 bit, single ended, V _{DD} reference		64		dB
		1 MSamples/s, 12 bit, differential, internal 1.25V reference		60		dB
		1 MSamples/s, 12 bit, differential, internal 2.5V reference		64		dB
		1 MSamples/s, 12 bit, differential, 5V reference		54		dB
		1 MSamples/s, 12 bit, differential, V _{DD} reference		66		dB
		1 MSamples/s, 12 bit, differential, 2xV _{DD} reference		68		dB
		200 kSamples/s, 12 bit, single ended, internal 1.25V reference		61		dB
		200 kSamples/s, 12 bit, single ended, internal 2.5V reference		65		dB
		200 kSamples/s, 12 bit, single ended, V _{DD} reference		66		dB
		200 kSamples/s, 12 bit, differential, internal 1.25V reference		63		dB
		200 kSamples/s, 12 bit, differential, internal 2.5V reference		66		dB
		200 kSamples/s, 12 bit, differential, 5V reference		66		dB
		200 kSamples/s, 12 bit, differential, V _{DD} reference		68		dB
		200 kSamples/s, 12 bit, differential, 2xV _{DD} reference		69		dB
SNDR _{ADC}	Signal to Noise-puls-Distortion Ratio (SNDR)					

Symbol	Parameter	Condition	Min	Typ	Max	Unit
SFDR _{ADC}	Spurious-Free Dynamic Range (SFDR)	1 MSamples/s, 12 bit, single ended, internal 1.25V reference		64		dBc
		1 MSamples/s, 12 bit, single ended, internal 2.5V reference		76		dBc
		1 MSamples/s, 12 bit, single ended, V _{DD} reference		73		dBc
		1 MSamples/s, 12 bit, differential, internal 1.25V reference		66		dBc
		1 MSamples/s, 12 bit, differential, internal 2.5V reference		77		dBc
		1 MSamples/s, 12 bit, differential, V _{DD} reference		76		dBc
		1 MSamples/s, 12 bit, differential, 2xV _{DD} reference		75		dBc
		1 MSamples/s, 12 bit, differential, 5V reference		69		dBc
		200 kSamples/s, 12 bit, single ended, internal 1.25V reference		75		dBc
		200 kSamples/s, 12 bit, single ended, internal 2.5V reference		75		dBc
		200 kSamples/s, 12 bit, single ended, V _{DD} reference		76		dBc
		200 kSamples/s, 12 bit, differential, internal 1.25V reference		79		dBc
		200 kSamples/s, 12 bit, differential, internal 2.5V reference		79		dBc
		200 kSamples/s, 12 bit, differential, 5V reference		78		dBc
		200 kSamples/s, 12 bit, differential, V _{DD} reference		79		dBc
		200 kSamples/s, 12 bit, differential, 2xV _{DD} reference		79		dBc
V _{ADCOFFSET}	Offset voltage	After calibration, single ended		0.3		mV
		After calibration, differential		0.3		mV
TGRAD _{ADCTH}	Thermometer output gradient			-1.92		mV/°C
				-6.3		ADC Codes/°C
DNL _{ADC}	Differential non-linearity (DNL)			±0.7		LSB
INL _{ADC}	Integral non-linearity (INL), End point method			±1.2		LSB

Symbol	Parameter	Condition	Min	Typ	Max	Unit
MC _{ADC}	No missing codes		11.999 ¹	12		bits

¹On the average every ADC will have one missing code, most likely to appear around 2048 +/- n*512 where n can be a value in the set {-3, -2, -1, 1, 2, 3}. There will be no missing code around 2048, and in spite of the missing code the ADC will be monotonic at all times so that a response to a slowly increasing input will always be a slowly increasing output. Around the one code that is missing, the neighbour codes will look wider in the DNL plot. The spectra will show spurs on the level of -78dBc for a full scale input for chips that have the missing code issue.

The integral non-linearity (INL) and differential non-linearity parameters are explained in Figure 3.28 (p. 37) and Figure 3.29 (p. 37) , respectively.

Figure 3.28. Integral Non-Linearity (INL)

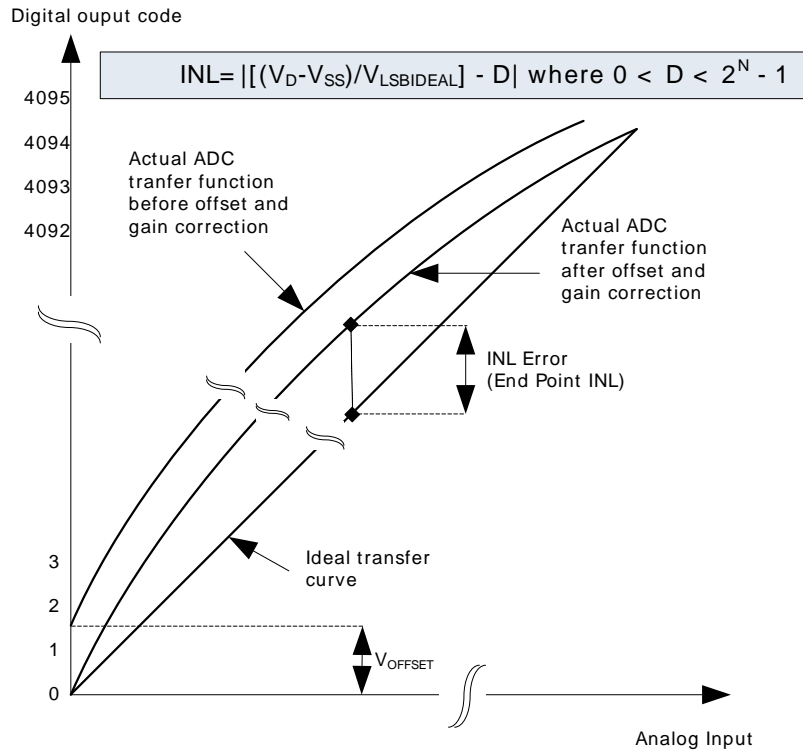
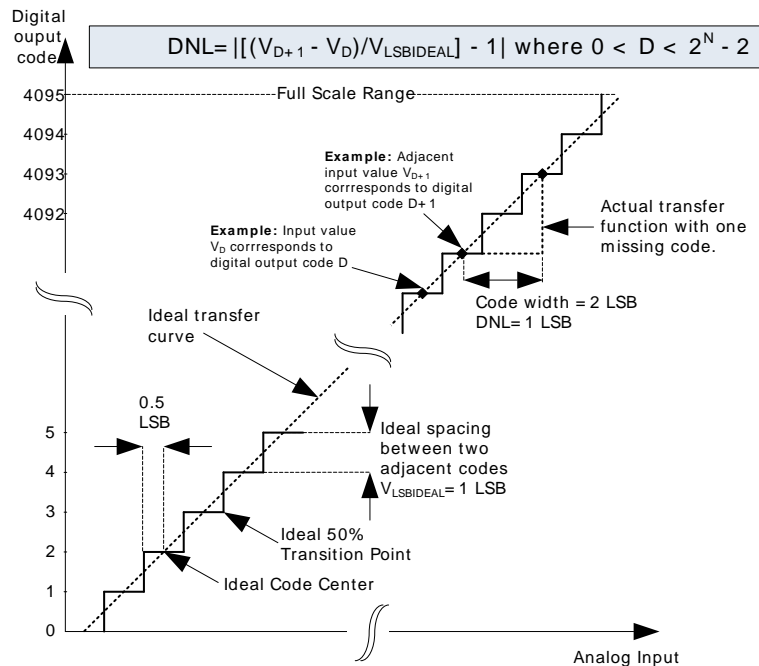
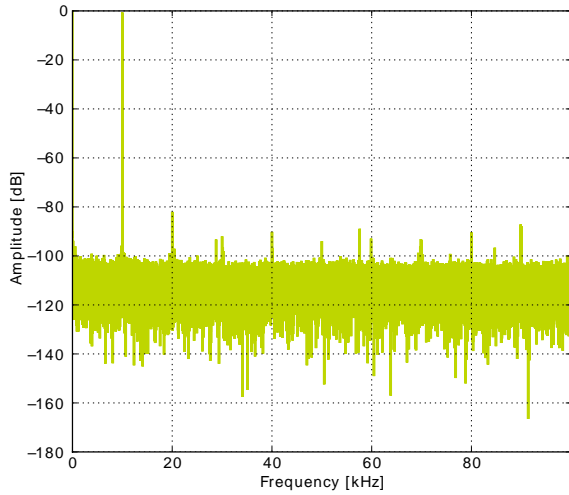

Figure 3.29. Differential Non-Linearity (DNL)



3.10.1 Typical performance

Figure 3.30. ADC Frequency Spectrum, Vdd = 3V, Temp = 25°



1.25V Reference

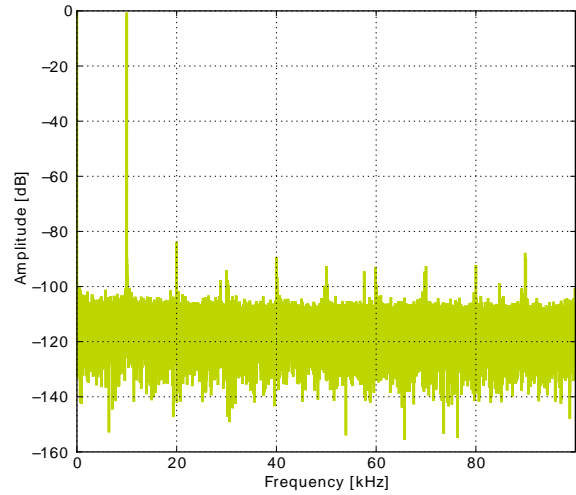

2.5V Reference

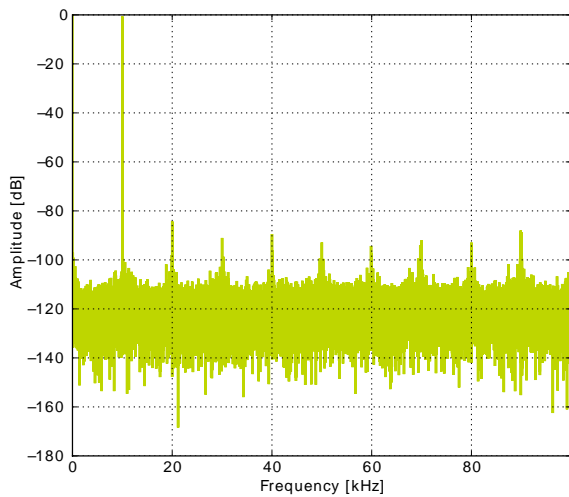

2XVDDVSS Reference

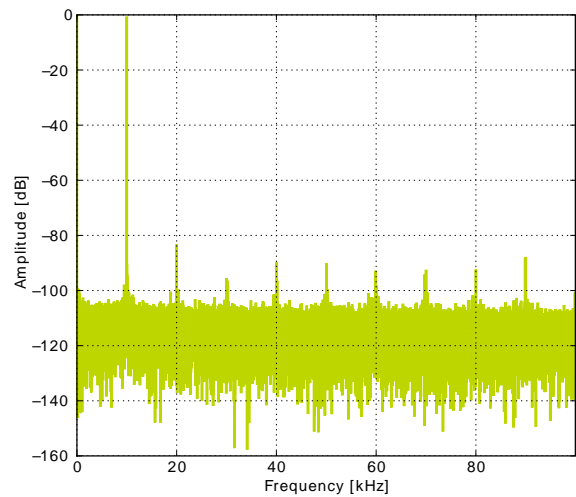

5VDIFF Reference

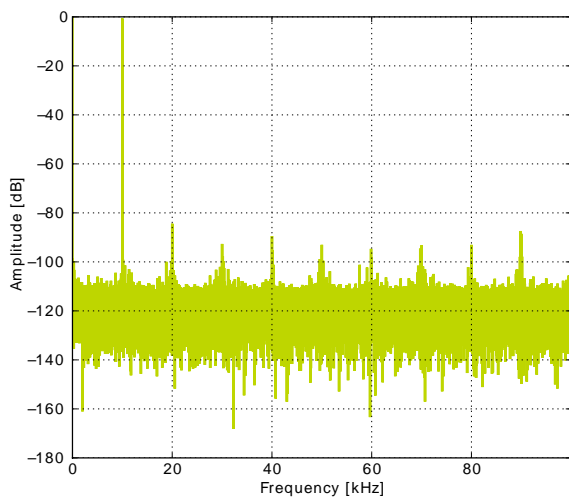

VDD Reference

Figure 3.31. ADC Integral Linearity Error vs Code, Vdd = 3V, Temp = 25°

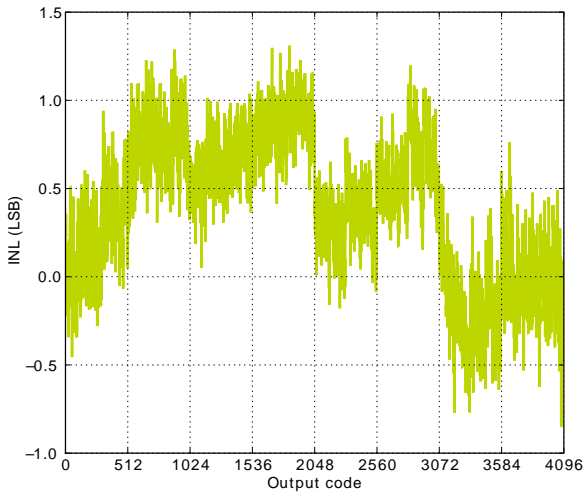

1.25V Reference

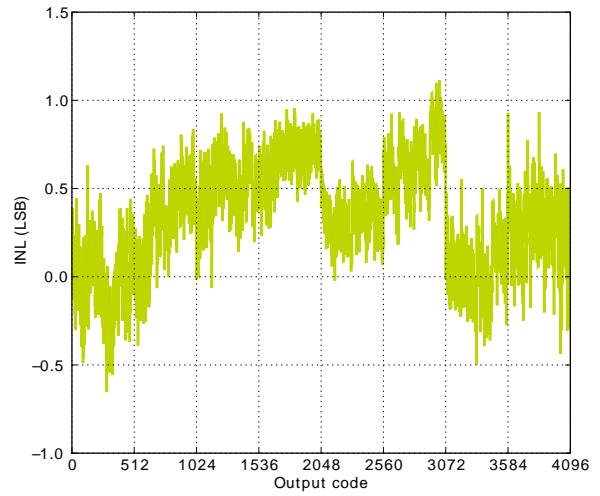

2.5V Reference

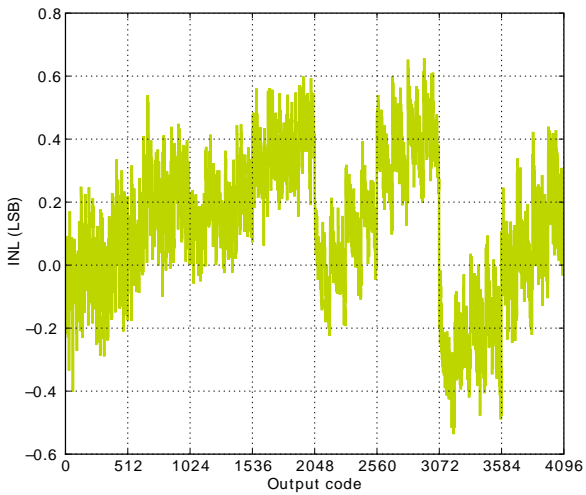

2XVDDVSS Reference

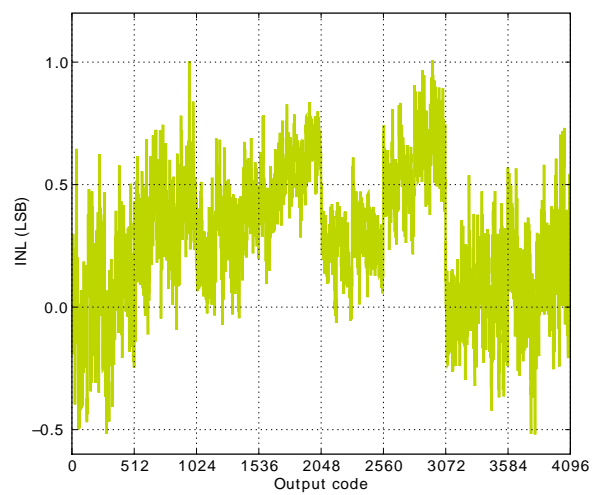

5VDIFF Reference

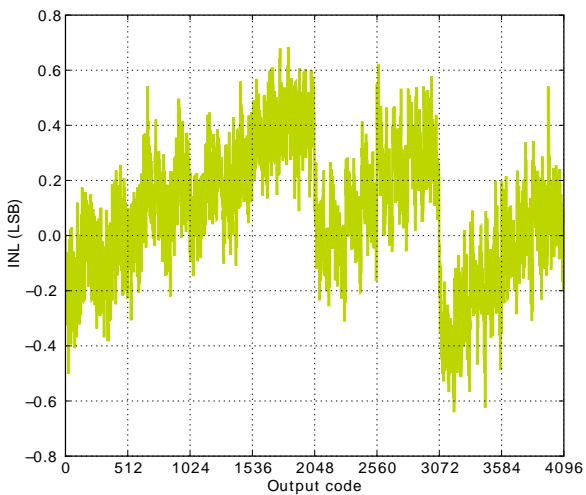

VDD Reference

Figure 3.32. ADC Differential Linearity Error vs Code, Vdd = 3V, Temp = 25°

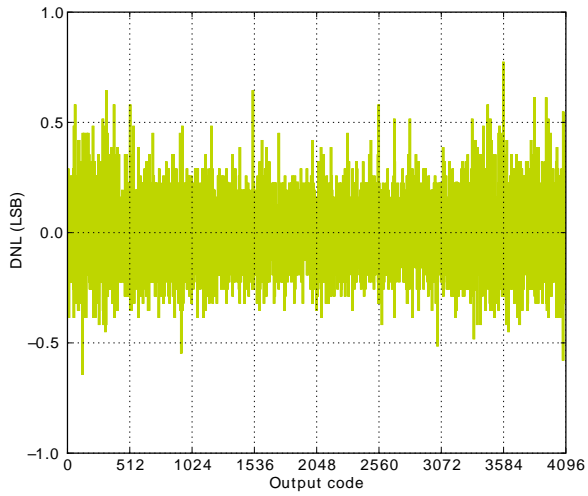

1.25V Reference

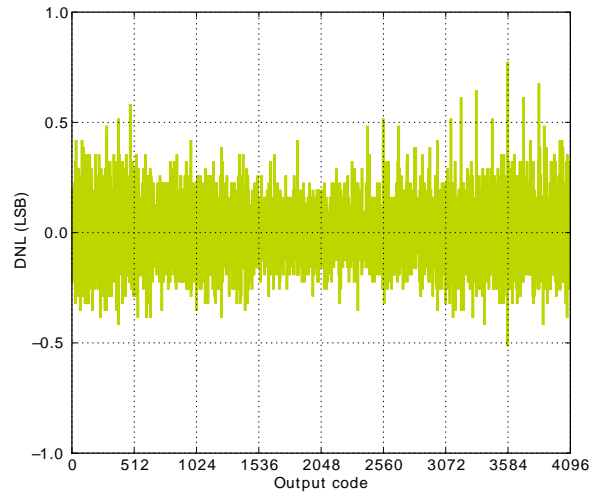

2.5V Reference

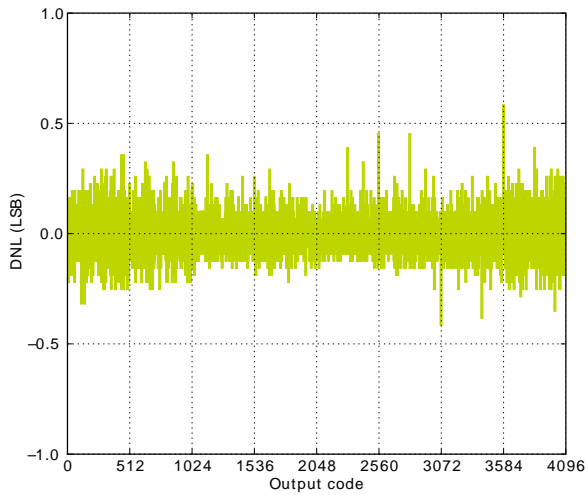

2XVDDVSS Reference

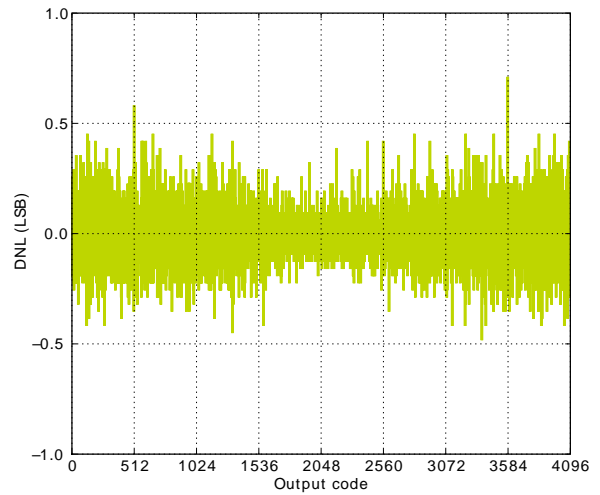

5VDIFF Reference

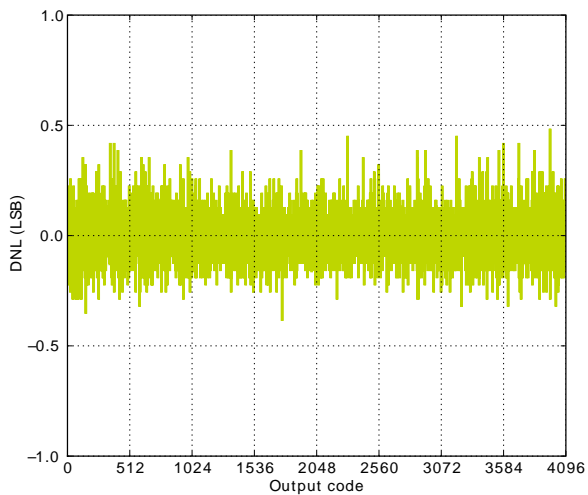

VDD Reference

Figure 3.33. ADC Absolute Offset, Common Mode = V_{DD} / 2

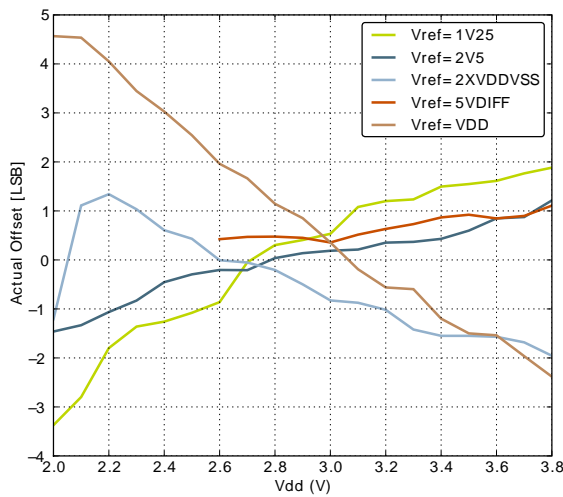

Offset vs Supply Voltage, Temp = 25°

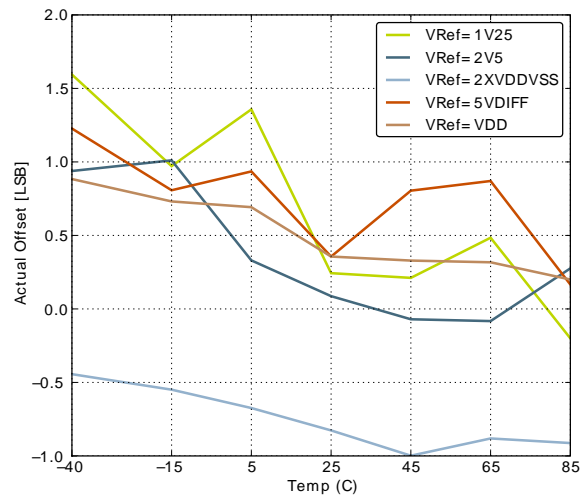

Offset vs Temperature, V_{DD} = 3V

Figure 3.34. ADC Dynamic Performance vs Temperature for all ADC References, V_{DD} = 3V

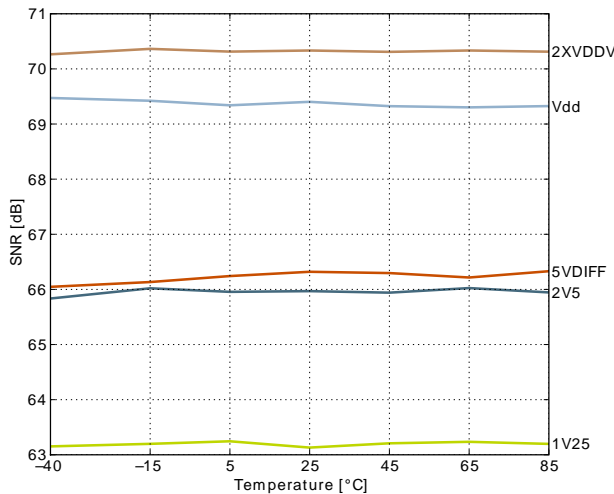

Signal to Noise Ratio (SNR)

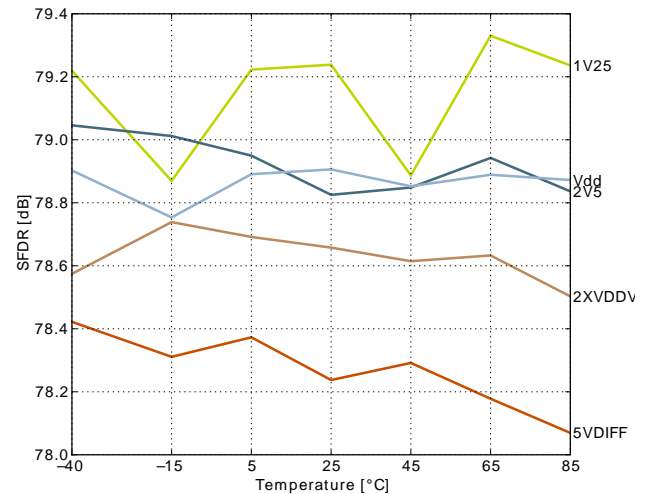

Spurious-Free Dynamic Range (SFDR)

3.11 Digital Analog Converter (DAC)

Table 3.16. DAC

Symbol	Parameter	Condition	Min	Typ	Max	Unit
V _{DACOUT}	Output voltage range	V _{DD} voltage reference, single ended	0		V _{DD}	V
V _{DACCM}	Output common mode voltage range		0		V _{DD}	V
I _{DAC}	Active current including references for 2 channels	500 kSamples/s, 12bit		400		μA
		100 kSamples/s, 12 bit		200		μA
		1 kSamples/s 12 bit		38		μA
SR _{DAC}	Sample rate				500	ksamples/s

Symbol	Parameter	Condition	Min	Typ	Max	Unit
f _{DAC}	DAC clock frequency	Continuous Mode			1000	kHz
		Sample/Hold Mode			250	kHz
		Sample/Off Mode			250	kHz
CYC _{DACCONV}	Clock cycles per conversion			2		
t _{DACCONV}	Conversion time		2			μs
t _{DACSETTLE}	Settling time			5		μs
SNR _{DAC}	Signal to Noise Ratio (SNR)	500 kSamples/s, 12 bit, single ended, internal 1.25V reference		58		dB
		500 kSamples/s, 12 bit, single ended, internal 2.5V reference		59		dB
SNDR _{DAC}	Signal to Noise-pulse Distortion Ratio (SNDR)	500 kSamples/s, 12 bit, single ended, internal 1.25V reference		57		dB
		500 kSamples/s, 12 bit, single ended, internal 2.5V reference		54		dB
SFDR _{DAC}	Spurious-Free Dynamic Range(SFDR)	500 kSamples/s, 12 bit, single ended, internal 1.25V reference		62		dBc
		500 kSamples/s, 12 bit, single ended, internal 2.5V reference		56		dBc
V _{DACOFFSET}	Offset voltage	After calibration, single ended		2		mV
V _{DACSHMDRIFT}	Sample-hold mode voltage drift			540		μV/ms
DNL _{DAC}	Differential non-linearity			±1		LSB
INL _{DAC}	Integral non-linearity			±5		LSB
MC _{DAC}	No missing codes			12		bits

3.12 Analog Comparator (ACMP)

Table 3.17. ACMP

Symbol	Parameter	Condition	Min	Typ	Max	Unit
V _{ACMPIN}	Input voltage range		0		V _{DD}	V
V _{ACMPCM}	ACMP Common Mode voltage range		0		V _{DD}	V
I _{ACMP}	Active current	BIASPROG=0b0000, FULL-BIAS=0 and HALFBIAS=1 in ACMPn_CTRL register		55		nA
		BIASPROG=0b1111, FULL-BIAS=0 and HALFBIAS=0 in ACMPn_CTRL register		2.82		μA
		BIASPROG=0b1111, FULL-BIAS=1 and HALFBIAS=0 in ACMPn_CTRL register		195		μA
I _{ACMPREF}	Current consumption of internal voltage reference	Internal voltage reference off. Using external voltage reference		0		μA
		Internal voltage reference, LPREF=1		50		nA
		Internal voltage reference, LPREF=0		6		μA
V _{ACMPOFFSET}	Offset voltage	Single ended		10		mV
		Differential		10		mV
V _{ACMPHYST}	ACMP hysteresis	Programmable		17		mV
R _{CSRES}	Capacitive Sense Internal Resistance	CSRESSEL=0b00 in ACMPn_INPUTSEL		39		kOhm
		CSRESSEL=0b01 in ACMPn_INPUTSEL		71		kOhm
		CSRESSEL=0b10 in ACMPn_INPUTSEL		104		kOhm
		CSRESSEL=0b11 in ACMPn_INPUTSEL		136		kOhm

The total ACMP current is the sum of the contributions from the ACMP and its internal voltage reference as given in Equation 3.1 (p. 43) . I_{ACMPREF} is zero if an external voltage reference is used.

Total ACMP Active Current

$$I_{ACMPTOTAL} = I_{ACMP} + I_{ACMPREF} \tag{3.1}$$

Figure 3.35. Typical ACMP Characteristics

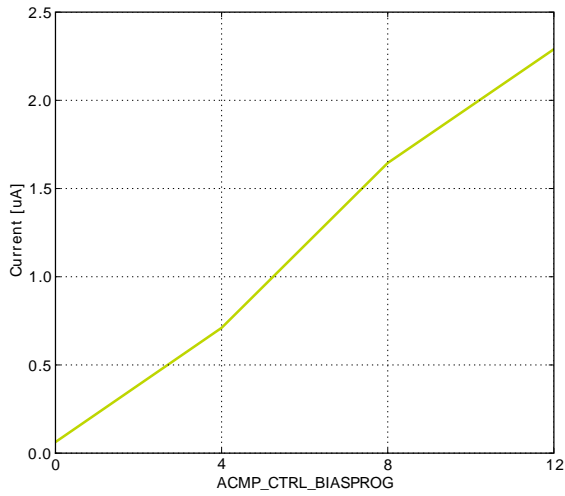

Current consumption

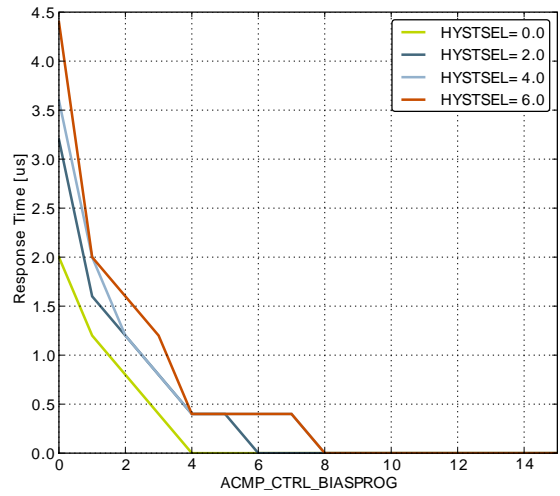

Response time

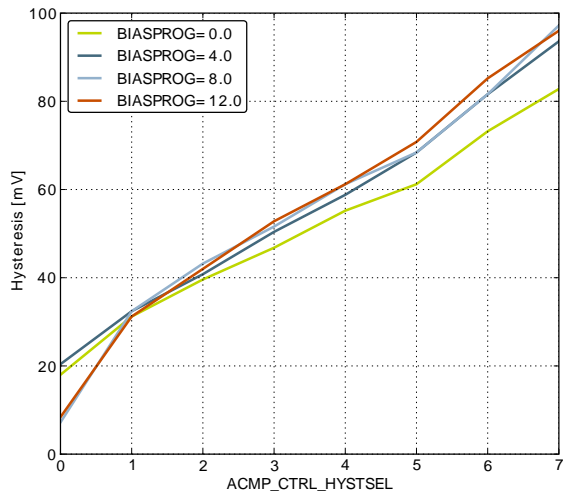

Hysteresis

3.13 Voltage Comparator (VCMP)

Table 3.18. VCMP

Symbol	Parameter	Condition	Min	Typ	Max	Unit
V _{VCMPIN}	Input voltage range			V _{DD}		V
V _{VCMP_{CM}}	VCMP Common Mode voltage range			V _{DD}		V
I _{VCMP}	Active current	BIASPROG=0b0000 and HALFBIAS=1 in VCMPn_CTRL register		0.1		μA
		BIASPROG=0b1111 and HALFBIAS=0 in VCMPn_CTRL register. LPREF=0.		14.7		μA
t _{VCMPREF}	Startup time reference generator	NORMAL		10		μs
V _{VCMP_{OFFSET}}	Offset voltage	Single ended		10		mV
		Differential		10		mV
V _{VCMP_{HYST}}	VCMP hysteresis			17		mV

The V_{DD} trigger level can be configured by setting the TRIGLEVEL field of the VCMP_CTRL register in accordance with the following equation:

VCMP Trigger Level as a Function of Level Setting

$$V_{DD \text{ Trigger Level}} = 1.667V + 0.034 \times \text{TRIGLEVEL} \tag{3.2}$$

3.14 Digital Peripherals

Table 3.19. Digital Peripherals

Symbol	Parameter	Condition	Min	Typ	Max	Unit
I _{USART}	USART current	USART idle current, clock enabled		7.5		μA/ MHz
I _{UART}	UART current	UART idle current, clock enabled		5.63		μA/ MHz
I _{LEUART}	LEUART current	LEUART idle current, clock enabled		150		nA
I _{I2C}	I2C current	I2C idle current, clock enabled		6.25		μA/ MHz
I _{TIMER}	TIMER current	TIMER_0 idle current, clock enabled		8.75		μA/ MHz
I _{LETIMER}	LETIMER current	LETIMER idle current, clock enabled		150		nA
I _{PCNT}	PCNT current	PCNT idle current, clock enabled		100		nA
I _{RTC}	RTC current	RTC idle current, clock enabled		100		nA
I _{AES}	AES current	AES idle current, clock enabled		2.5		μA/ MHz

Symbol	Parameter	Condition	Min	Typ	Max	Unit
I _{GPIO}	GPIO current	GPIO idle current, clock enabled		5.31		μA/ MHz
I _{PRS}	PRS current	PRS idle current		2,81		μA/ MHz
I _{DMA}	DMA current	Clock enable		8.12		μA/ MHz

4 Pinout and Package

Note

Please refer to the application note "AN0002 EFM32 Hardware Design Considerations" for guidelines on designing Printed Circuit Boards (PCB's) for the EFM32G222.

4.1 Pinout

The EFM32G222 pinout is shown in Figure 4.1 (p. 47) and Table 4.1 (p. 47). Alternate locations are denoted by "#" followed by the location number (Multiple locations on the same pin are split with "/"). Alternate locations can be configured in the LOCATION bitfield in the *_ROUTE register in the module in question.

Figure 4.1. EFM32G222 Pinout (top view, not to scale)

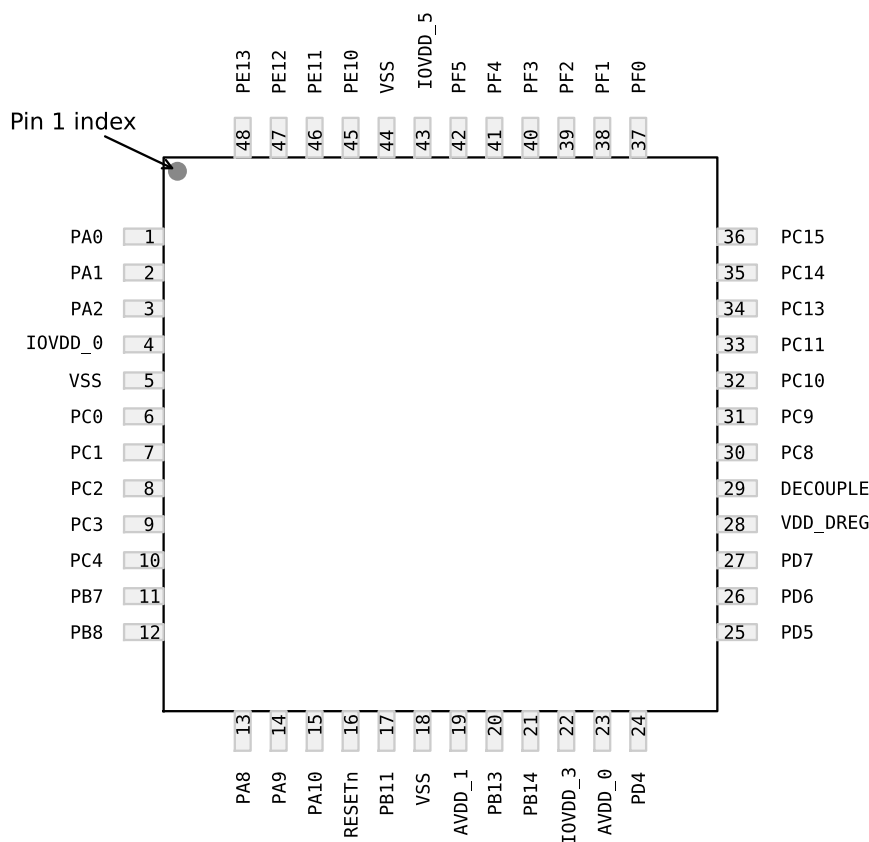

Table 4.1. Device Pinout

QFP48 Pin# and Name		Pin Alternate Functionality / Description			
Pin #	Pin Name	Analog	Timers	Communication	Other
1	PA0		TIM0_CC0 #0/1	I2C0_SDA #0	
2	PA1		TIM0_CC1 #0/1	I2C0_SCL #0	CMU_CLK1 #0
3	PA2		TIM0_CC2 #0/1		CMU_CLK0 #0

QFP48 Pin# and Name		Pin Alternate Functionality / Description			
Pin #	Pin Name	Analog	Timers	Communication	Other
4	IOVDD_0	Digital IO power supply 0.			
5	VSS	Ground			
6	PC0	ACMP0_CH0	PCNT0_S0IN #2	US1_TX #0	
7	PC1	ACMP0_CH1	PCNT0_S1IN #2	US1_RX #0	
8	PC2	ACMP0_CH2			
9	PC3	ACMP0_CH3			
10	PC4	ACMP0_CH4	LETIM0_OUT0 #3 PCNT1_S0IN #0		
11	PB7	LFXTAL_P		US1_CLK #0	
12	PB8	LFXTAL_N		US1_CS #0	
13	PA8		TIM2_CC0 #0		
14	PA9		TIM2_CC1 #0		
15	PA10		TIM2_CC2 #0		
16	RESETn	Reset input. Active low, with internal pull-up.			
17	PB11	DAC0_OUT0	LETIM0_OUT0 #1		
18	VSS	Ground			
19	AVDD_1	Analog power supply 1 .			
20	PB13	HFXTAL_P		LEU0_TX #1	
21	PB14	HFXTAL_N		LEU0_RX #1	
22	IOVDD_3	Digital IO power supply 3.			
23	AVDD_0	Analog power supply 0.			
24	PD4	ADC0_CH4		LEU0_TX #0	
25	PD5	ADC0_CH5		LEU0_RX #0	
26	PD6	ADC0_CH6	LETIM0_OUT0 #0	I2C0_SDA #1	
27	PD7	ADC0_CH7	LETIM0_OUT1 #0	I2C0_SCL #1	
28	VDD_DREG	Power supply for on-chip voltage regulator.			
29	DECOUPLE	Decouple output for on-chip voltage regulator. An external capacitance of size C _{DECOUPLE} is required at this pin.			
30	PC8	ACMP1_CH0	TIM2_CC0 #2	US0_CS #2	
31	PC9	ACMP1_CH1	TIM2_CC1 #2	US0_CLK #2	
32	PC10	ACMP1_CH2	TIM2_CC2 #2	US0_RX #2	
33	PC11	ACMP1_CH3		US0_TX #2	
34	PC13	ACMP1_CH5	TIM0_CDTI0 #1/3 TIM1_CC0 #0 PCNT0_S0IN #0		
35	PC14	ACMP1_CH6	TIM0_CDTI1 #1/3 TIM1_CC1 #0 PCNT0_S1IN #0		
36	PC15	ACMP1_CH7	TIM0_CDTI2 #1/3 TIM1_CC2 #0		DBG_SWO #1
37	PF0		LETIM0_OUT0 #2		DBG_SWCLK #0/1
38	PF1		LETIM0_OUT1 #2		DBG_SWDIO #0/1
39	PF2				ACMP1_O #0

QFP48 Pin# and Name		Pin Alternate Functionality / Description			
Pin #	Pin Name	Analog	Timers	Communication	Other
					DBG_SWO #0
40	PF3		TIM0_CDTI0 #2		
41	PF4		TIM0_CDTI1 #2		
42	PF5		TIM0_CDTI2 #2		
43	IOVDD_5	Digital IO power supply 5.			
44	VSS	Ground			
45	PE10		TIM1_CC0 #1	US0_TX #0	
46	PE11		TIM1_CC1 #1	US0_RX #0	
47	PE12		TIM1_CC2 #1	US0_CLK #0	
48	PE13			US0_CS #0	ACMP0_O #0

4.2 Alternate functionality pinout

A wide selection of alternate functionality is available for multiplexing to various pins. This is shown in Table 4.2 (p. 49). The table shows the name of the alternate functionality in the first column, followed by columns showing the possible LOCATION bitfield settings.

Note

Some functionality, such as analog interfaces, do not have alternate settings or a LOCATION bitfield. In these cases, the pinout is shown in the column corresponding to LOCATION 0.

Table 4.2. Alternate functionality overview

Alternate Functionality	LOCATION				Description
	0	1	2	3	
ACMP0_CH0	PC0				Analog comparator ACMP0, channel 0.
ACMP0_CH1	PC1				Analog comparator ACMP0, channel 1.
ACMP0_CH2	PC2				Analog comparator ACMP0, channel 2.
ACMP0_CH3	PC3				Analog comparator ACMP0, channel 3.
ACMP0_CH4	PC4				Analog comparator ACMP0, channel 4.
ACMP0_O	PE13				Analog comparator ACMP0, digital output.
ACMP1_CH0	PC8				Analog comparator ACMP1, channel 0.
ACMP1_CH1	PC9				Analog comparator ACMP1, channel 1.
ACMP1_CH2	PC10				Analog comparator ACMP1, channel 2.
ACMP1_CH3	PC11				Analog comparator ACMP1, channel 3.
ACMP1_CH5	PC13				Analog comparator ACMP1, channel 5.
ACMP1_CH6	PC14				Analog comparator ACMP1, channel 6.
ACMP1_CH7	PC15				Analog comparator ACMP1, channel 7.
ACMP1_O	PF2				Analog comparator ACMP1, digital output.
ADC0_CH4	PD4				Analog to digital converter ADC0, input channel number 4.
ADC0_CH5	PD5				Analog to digital converter ADC0, input channel number 5.
ADC0_CH6	PD6				Analog to digital converter ADC0, input channel number 6.

Alternate	LOCATION				Description
	0	1	2	3	
ADC0_CH7	PD7				Analog to digital converter ADC0, input channel number 7.
CMU_CLK0	PA2				Clock Management Unit, clock output number 0.
CMU_CLK1	PA1				Clock Management Unit, clock output number 1.
DAC0_OUT0	PB11				Digital to Analog Converter DAC0 output channel number 0.
DBG_SWCLK	PF0	PF0			Debug-interface Serial Wire clock input. Note that this function is enabled to pin out of reset, and has a built-in pull down.
DBG_SWDIO	PF1	PF1			Debug-interface Serial Wire data input / output. Note that this function is enabled to pin out of reset, and has a built-in pull up.
DBG_SWO	PF2	PC15			Debug-interface Serial Wire viewer Output. Note that this function is not enabled after reset, and must be enabled by software to be used.
HFX TAL_N	PB14				High Frequency Crystal (4 - 32 MHz) negative pin. Also used as external optional clock input pin.
HFX TAL_P	PB13				High Frequency Crystal (4 - 32 MHz) positive pin.
I2C0_SCL	PA1	PD7			I2C0 Serial Clock Line input / output.
I2C0_SDA	PA0	PD6			I2C0 Serial Data input / output.
LETIM0_OUT0	PD6	PB11	PF0	PC4	Low Energy Timer LETIM0, output channel 0.
LETIM0_OUT1	PD7		PF1		Low Energy Timer LETIM0, output channel 1.
LEU0_RX	PD5	PB14			LEUART0 Receive input.
LEU0_TX	PD4	PB13			LEUART0 Transmit output. Also used as receive input in half duplex communication.
LFXTAL_N	PB8				Low Frequency Crystal (typically 32.768 kHz) negative pin. Also used as an optional external clock input pin.
LFXTAL_P	PB7				Low Frequency Crystal (typically 32.768 kHz) positive pin.
PCNT0_S0IN	PC13		PC0		Pulse Counter PCNT0 input number 0.
PCNT0_S1IN	PC14		PC1		Pulse Counter PCNT0 input number 1.
PCNT1_S0IN	PC4				Pulse Counter PCNT1 input number 0.
TIM0_CC0	PA0	PA0			Timer 0 Capture Compare input / output channel 0.
TIM0_CC1	PA1	PA1			Timer 0 Capture Compare input / output channel 1.
TIM0_CC2	PA2	PA2			Timer 0 Capture Compare input / output channel 2.
TIM0_CDTI0		PC13	PF3	PC13	Timer 0 Complimentary Deat Time Insertion channel 0.
TIM0_CDTI1		PC14	PF4	PC14	Timer 0 Complimentary Deat Time Insertion channel 1.
TIM0_CDTI2		PC15	PF5	PC15	Timer 0 Complimentary Deat Time Insertion channel 2.
TIM1_CC0	PC13	PE10			Timer 1 Capture Compare input / output channel 0.
TIM1_CC1	PC14	PE11			Timer 1 Capture Compare input / output channel 1.
TIM1_CC2	PC15	PE12			Timer 1 Capture Compare input / output channel 2.
TIM2_CC0	PA8		PC8		Timer 2 Capture Compare input / output channel 0.
TIM2_CC1	PA9		PC9		Timer 2 Capture Compare input / output channel 1.
TIM2_CC2	PA10		PC10		Timer 2 Capture Compare input / output channel 2.
US0_CLK	PE12		PC9		USART0 clock input / output.
US0_CS	PE13		PC8		USART0 chip select input / output.
US0_RX	PE11		PC10		USART0 Asynchronous Receive. USART0 Synchronous mode Master Input / Slave Output (MISO).

Alternate	LOCATION				Description
Functionality	0	1	2	3	
US0_TX	PE10		PC11		USART0 Asynchronous Transmit. Also used as receive input in half duplex communication. USART0 Synchronous mode Master Output / Slave Input (MOSI).
US1_CLK	PB7				USART1 clock input / output.
US1_CS	PB8				USART1 chip select input / output.
US1_RX	PC1				USART1 Asynchronous Receive. USART1 Synchronous mode Master Input / Slave Output (MISO).
US1_TX	PC0				USART1 Asynchronous Transmit. Also used as receive input in half duplex communication. USART1 Synchronous mode Master Output / Slave Input (MOSI).

4.3 GPIO pinout overview

The specific GPIO pins available in *EFM32G222* is shown in Table 4.3 (p. 51). Each GPIO port is organized as 16-bit ports indicated by letters A through F, and the individual pin on this port is indicated by a number from 15 down to 0.

Table 4.3. GPIO Pinout

Port	Pin 15	Pin 14	Pin 13	Pin 12	Pin 11	Pin 10	Pin 9	Pin 8	Pin 7	Pin 6	Pin 5	Pin 4	Pin 3	Pin 2	Pin 1	Pin 0
Port A	-	-	-	-	-	PA10	PA9	PA8	-	-	-	-	-	PA2	PA1	PA0
Port B	-	PB14	PB13	-	PB11	-	-	PB8	PB7	-	-	-	-	-	-	-
Port C	PC15	PC14	PC13	-	PC11	PC10	PC9	PC8	-	-	-	PC4	PC3	PC2	PC1	PC0
Port D	-	-	-	-	-	-	-	-	PD7	PD6	PD5	PD4	-	-	-	-
Port E	-	-	PE13	PE12	PE11	PE10	-	-	-	-	-	-	-	-	-	-
Port F	-	-	-	-	-	-	-	-	-	-	PF5	PF4	PF3	PF2	PF1	PF0

4.4 TQFP48 Package

Figure 4.2. TQFP48

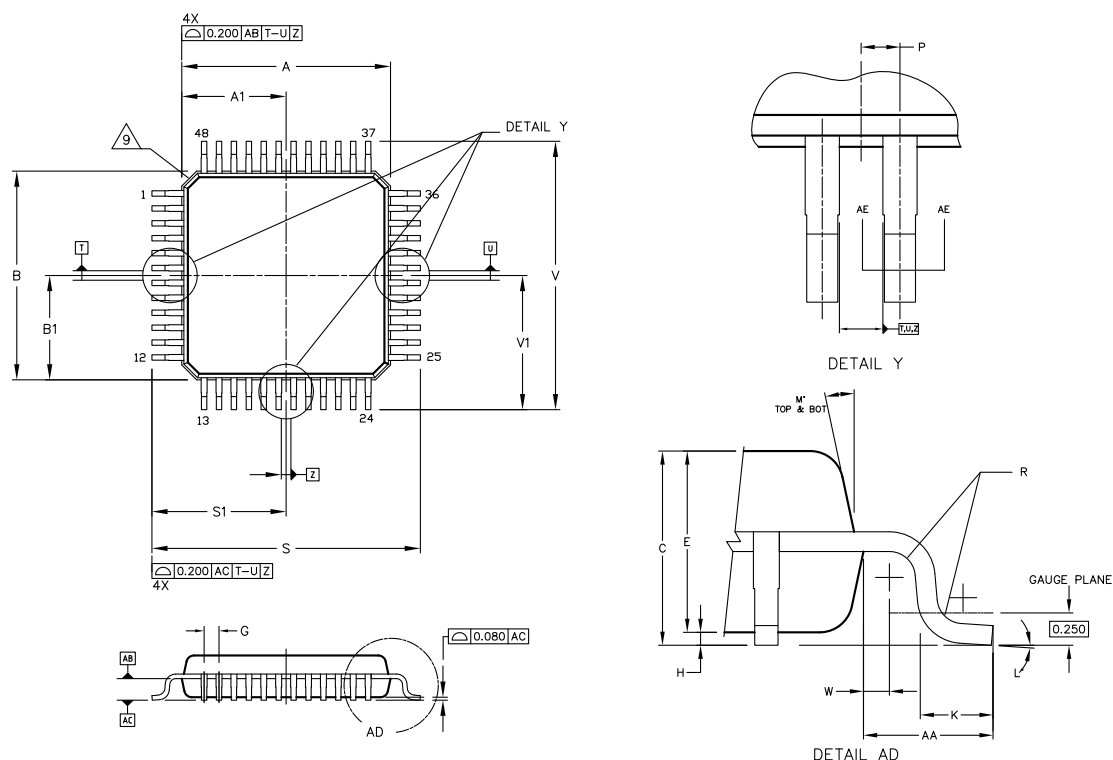

Rev: 98SPP48097A_XC_30Mar11

Note:

1. Dimensions and tolerance per ASME Y14.5M-1994
2. Control dimension: Millimeter.
3. Datum plane AB is located at bottom of lead and is coincident with the lead where the lead exists from the plastic body at the bottom of the parting line.
4. Datums T, U and Z to be determined at datum plane AB.
5. Dimensions S and V to be determined at seating plane AC.
6. Dimensions A and B do not include mold protrusion. Allowable protrusion is 0.250 per side. Dimensions A and B do include mold mismatch and are determined at datum AB.
7. Dimension D does not include dambar protrusion. Dambar protrusion shall not cause the D dimension to exceed 0.350.
8. Minimum solder plate thickness shall be 0.0076.
9. Exact shape of each corner is optional.

Table 4.4. QFP48 (Dimensions in mm)

DIM	MIN	NOM	MAX	DIM	MIN	NOM	MAX
A	-	7.000 BSC	-	M	-	12DEG REF	-
A1	-	3.500 BSC	-	N	0.090	-	0.160
B	-	7.000 BSC	-	P	-	0.250 BSC	-
B1	-	3.500 BSC	-	R	0.150	-	0.250
C	1.000	-	1.200	S	-	9.000 BSC	-

DIM	MIN	NOM	MAX	DIM	MIN	NOM	MAX
D	0.170	-	0.270	S1	-	4.500 BSC	-
E	0.950	-	1.050	V	-	9.000 BSC	-
F	0.170	-	0.230	V1	-	4.500 BSC	-
G	-	0.500 BSC	-	W	-	0.200 BSC	-
H	0.050	-	0.150	AA	-	1.000 BSC	-
J	0.090	-	0.200				
K	0.500	-	0.700				
L	0DEG	-	7DEG				

The TQFP48 Package is 7 by 7 mm in size and has a 0.5 mm pin pitch.

The TQFP48 Package uses Nickel-Palladium-Gold preplated leadframe.

All EFM32 packages are RoHS compliant and free of Bromine (Br) and Antimony (Sb).

5 PCB Layout and Soldering

5.1 Recommended PCB Layout

Figure 5.1. TQFP48 PCB Land Pattern

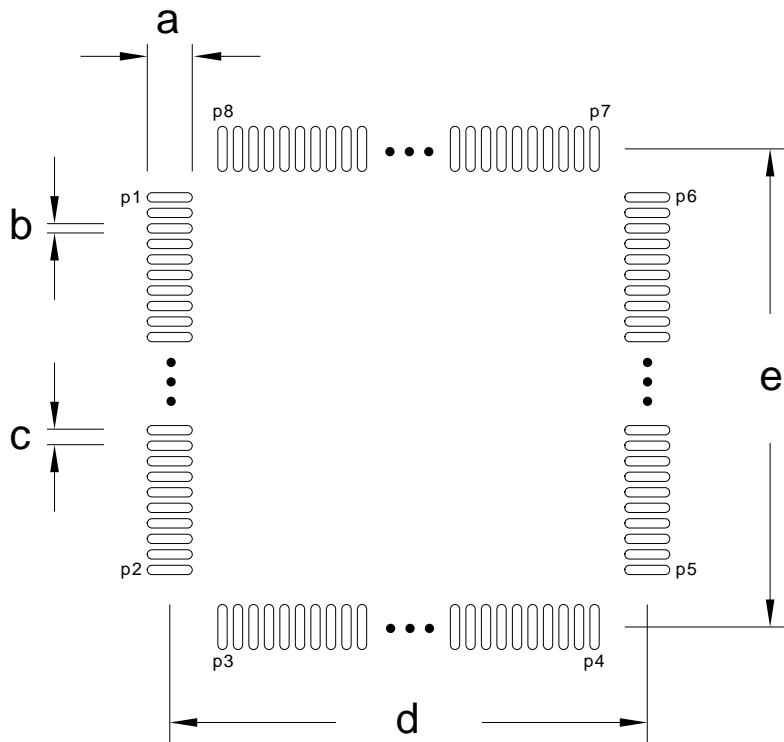

Table 5.1. QFP48 PCB Land Pattern Dimensions (Dimensions in mm)

Symbol	Dim. (mm)	Symbol	Pin number	Symbol	Pin number
a	1.60	P1	1	P6	36
b	0.30	P2	12	P7	37
c	0.50	P3	13	P8	48
d	8.50	P4	24	-	-
e	8.50	P5	25	-	-

Figure 5.2. TQFP48 PCB Solder Mask

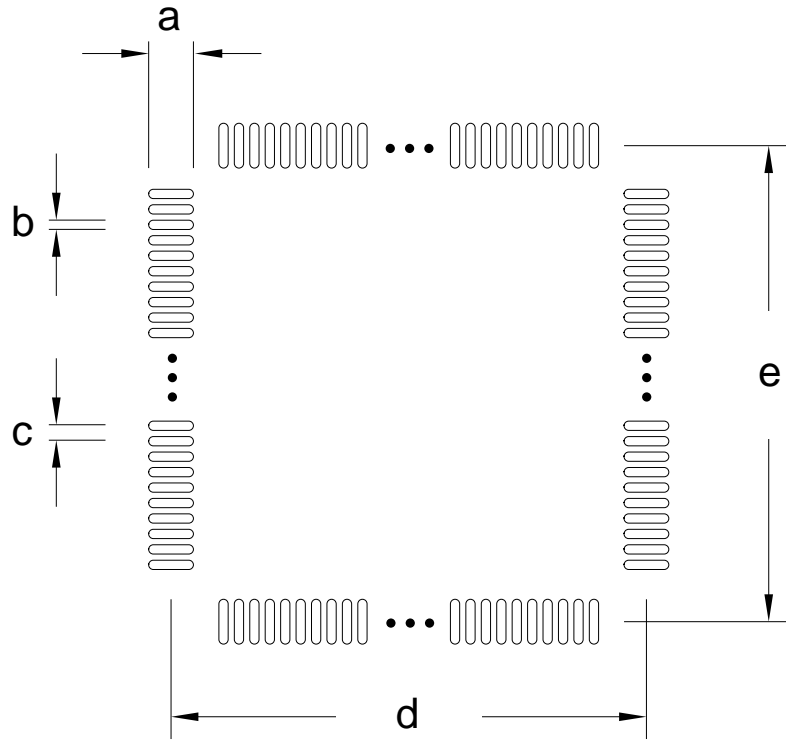

Table 5.2. QFP48 PCB Solder Mask Dimensions (Dimensions in mm)

Symbol	Dim. (mm)
a	1.72
b	0.42
c	0.50
d	8.50
e	8.50

Figure 5.3. TQFP48 PCB Stencil Design

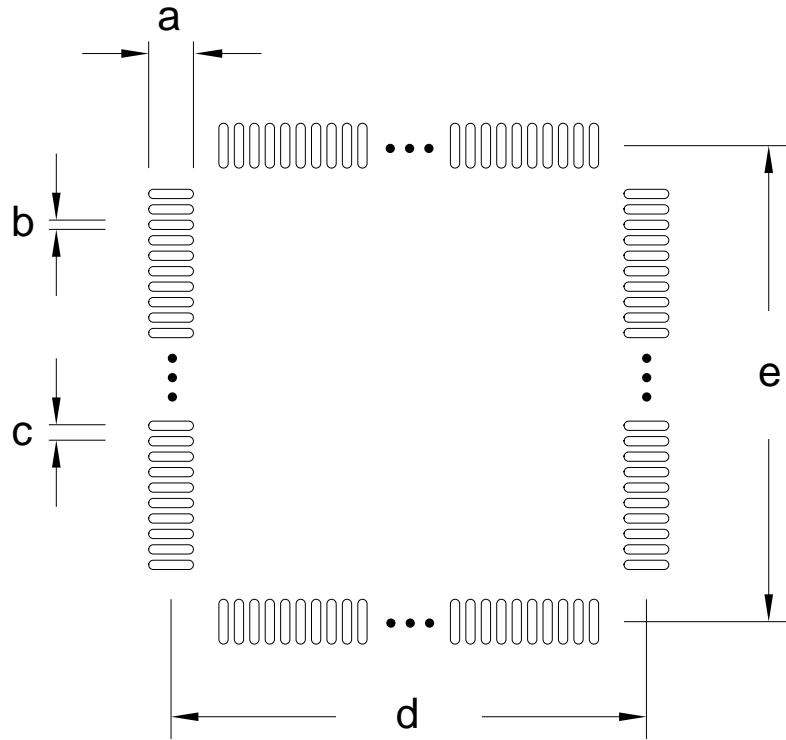

Table 5.3. QFP48 PCB Stencil Design Dimensions (Dimensions in mm)

Symbol	Dim. (mm)
a	1.50
b	0.20
c	0.50
d	8.50
e	8.50

1. The drawings are not to scale.
2. All dimensions are in millimeters.
3. All drawings are subject to change without notice.
4. The PCB Land Pattern drawing is in compliance with IPC-7351B.
5. Stencil thickness 0.125 mm.

5.2 Soldering Information

The latest IPC/JEDEC J-STD-020 recommendations for Pb-Free reflow soldering should be followed.

The packages have a Moisture Sensitivity Level rating of 3, please see the latest IPC/JEDEC J-STD-033 standard for MSL description and level 3 bake conditions.

6 Chip Marking, Revision and Errata

6.1 Chip Marking

In the illustration below package fields and position are shown.

Figure 6.1. Example Chip Marking

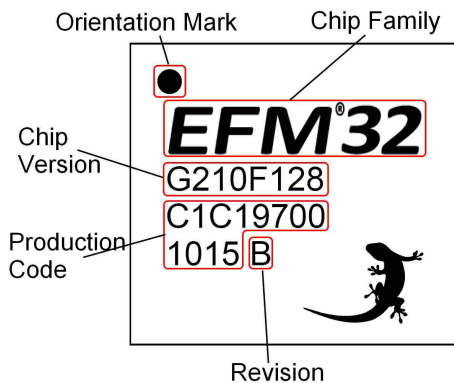

6.2 Revision

The revision of a chip can be determined from the "Revision" field in Figure 6.1 (p. 57). If the revision says "ES" (Engineering Sample), the revision must be read out electronically as specified in the reference manual.

6.3 Errata

Please see the [dxxx_efm32g222_errata.pdf](#) for description and resolution of device erratas. This document is available in Simplicity Studio or online at <http://www.energymicro.com/downloads/datasheets>.

7 Revision History

7.1 Revision 1.40

February 27nd, 2012

Updated Power Managment section.

Corrected operating voltage from 1.8 V to 1.85 V.

Corrected TGRAD_{ADCTH} parameter.

Corrected TQFP48 package drawing.

Updated PCB land pattern, solder mask and stencil design.

7.2 Revision 1.0

May 20th, 2011

Updated LFXO load capacitance section

7.3 Revision 0.90

Initial preliminary revision, April 14th, 2011

A Disclaimer and Trademarks

A.1 Disclaimer

Energy Micro AS intends to provide customers with the latest, accurate, and in-depth documentation of all peripherals and modules available for system and software implementers using or intending to use the Energy Micro products. Characterization data, available modules and peripherals, memory sizes and memory addresses refer to each specific device, and "Typical" parameters provided can and do vary in different applications. Application examples described herein are for illustrative purposes only. Energy Micro reserves the right to make changes without further notice and limitation to product information, specifications, and descriptions herein, and does not give warranties as to the accuracy or completeness of the included information. Energy Micro shall have no liability for the consequences of use of the information supplied herein. This document does not imply or express copyright licenses granted hereunder to design or fabricate any integrated circuits. The products must not be used within any Life Support System without the specific written consent of Energy Micro. A "Life Support System" is any product or system intended to support or sustain life and/or health, which, if it fails, can be reasonably expected to result in significant personal injury or death. Energy Micro products are generally not intended for military applications. Energy Micro products shall under no circumstances be used in weapons of mass destruction including (but not limited to) nuclear, biological or chemical weapons, or missiles capable of delivering such weapons.

A.2 Trademark Information

Energy Micro, EFM32, EFR, logo and combinations thereof, and others are the registered trademarks or trademarks of Energy Micro AS. ARM, CORTEX, THUMB are the registered trademarks of ARM Limited. Other terms and product names may be trademarks of others.

B Contact Information

B.1 Energy Micro Corporate Headquarters

Postal Address	Visitor Address	Technical Support
Energy Micro AS P.O. Box 4633 Nydalen N-0405 Oslo NORWAY	Energy Micro AS Sandakerveien 118 N-0484 Oslo NORWAY	support.energymicro.com Phone: +47 40 10 03 01

www.energymicro.com

Phone: +47 23 00 98 00

Fax: + 47 23 00 98 01

B.2 Global Contacts

Visit **www.energymicro.com** for information on global distributors and representatives or contact **sales@energymicro.com** for additional information.

Americas	Europe, Middle East and Africa	Asia and Pacific
www.energymicro.com/americas	www.energymicro.com/emea	www.energymicro.com/asia

Table of Contents

1. Ordering Information	2
2. System Summary	3
2.1. System Introduction	3
2.2. Configuration Summary	6
2.3. Memory Map	7
3. Electrical Characteristics	9
3.1. Test Conditions	9
3.2. Absolute Maximum Ratings	9
3.3. General Operating Conditions	9
3.4. Current Consumption	11
3.5. Transition between Energy Modes	18
3.6. Power Management	18
3.7. Flash	19
3.8. General Purpose Input Output	20
3.9. Oscillators	27
3.10. Analog Digital Converter (ADC)	33
3.11. Digital Analog Converter (DAC)	41
3.12. Analog Comparator (ACMP)	43
3.13. Voltage Comparator (VCMP)	45
3.14. Digital Peripherals	45
4. Pinout and Package	47
4.1. Pinout	47
4.2. Alternate functionality pinout	49
4.3. GPIO pinout overview	51
4.4. TQFP48 Package	52
5. PCB Layout and Soldering	54
5.1. Recommended PCB Layout	54
5.2. Soldering Information	56
6. Chip Marking, Revision and Errata	57
6.1. Chip Marking	57
6.2. Revision	57
6.3. Errata	57
7. Revision History	58
7.1. Revision 1.40	58
7.2. Revision 1.0	58
7.3. Revision 0.90	58
A. Disclaimer and Trademarks	59
A.1. Disclaimer	59
A.2. Trademark Information	59
B. Contact Information	60
B.1. Energy Micro Corporate Headquarters	60
B.2. Global Contacts	60

List of Figures

2.1. Block Diagram	3
2.2. EFM32G222 Memory Map with largest RAM and Flash sizes	8
3.1. EM0 Current consumption while executing prime number calculation code from flash with HFRCO running at 28MHz	12
3.2. EM0 Current consumption while executing prime number calculation code from flash with HFRCO running at 21MHz	12
3.3. EM0 Current consumption while executing prime number calculation code from flash with HFRCO running at 14MHz	13
3.4. EM0 Current consumption while executing prime number calculation code from flash with HFRCO running at 11MHz	13
3.5. EM0 Current consumption while executing prime number calculation code from flash with HFRCO running at 7MHz	14
3.6. EM1 Current consumption with all peripheral clocks disabled and HFRCO running at 28MHz	14
3.7. EM1 Current consumption with all peripheral clocks disabled and HFRCO running at 21MHz	15
3.8. EM1 Current consumption with all peripheral clocks disabled and HFRCO running at 14MHz	15
3.9. EM1 Current consumption with all peripheral clocks disabled and HFRCO running at 11MHz	16
3.10. EM1 Current consumption with all peripheral clocks disabled and HFRCO running at 7MHz	16
3.11. EM2 current consumption. RTC prescaled to 1kHz, 32 kHz LFRCO.	17
3.12. EM3 current consumption.	17
3.13. EM4 current consumption.	18
3.14. Typical Low-Level Output Current, 2V Supply Voltage	21
3.15. Typical High-Level Output Current, 2V Supply Voltage	22
3.16. Typical Low-Level Output Current, 3V Supply Voltage	23
3.17. Typical High-Level Output Current, 3V Supply Voltage	24
3.18. Typical Low-Level Output Current, 3.8V Supply Voltage	25
3.19. Typical High-Level Output Current, 3.8V Supply Voltage	26
3.20. Minimum Load Capacitance (C_{LFXOL}) Requirement For Safe Crystal Startup	27
3.21. Calibrated LFRCO Frequency vs Temperature and Supply Voltage	29
3.22. Calibrated HFRCO 1 MHz Band Frequency vs Temperature and Supply Voltage	31
3.23. Calibrated HFRCO 7 MHz Band Frequency vs Temperature and Supply Voltage	31
3.24. Calibrated HFRCO 11 MHz Band Frequency vs Temperature and Supply Voltage	31
3.25. Calibrated HFRCO 14 MHz Band Frequency vs Temperature and Supply Voltage	32
3.26. Calibrated HFRCO 21 MHz Band Frequency vs Temperature and Supply Voltage	32
3.27. Calibrated HFRCO 28 MHz Band Frequency vs Temperature and Supply Voltage	32
3.28. Integral Non-Linearity (INL)	37
3.29. Differential Non-Linearity (DNL)	37
3.30. ADC Frequency Spectrum, Vdd = 3V, Temp = 25°	38
3.31. ADC Integral Linearity Error vs Code, Vdd = 3V, Temp = 25°	39
3.32. ADC Differential Linearity Error vs Code, Vdd = 3V, Temp = 25°	40
3.33. ADC Absolute Offset, Common Mode = Vdd /2	41
3.34. ADC Dynamic Performance vs Temperature for all ADC References, Vdd = 3V	41
3.35. Typical ACMP Characteristics	44
4.1. EFM32G222 Pinout (top view, not to scale)	47
4.2. TQFP48	52
5.1. TQFP48 PCB Land Pattern	54
5.2. TQFP48 PCB Solder Mask	55
5.3. TQFP48 PCB Stencil Design	56
6.1. Example Chip Marking	57

List of Tables

1.1. Ordering Information	2
2.1. Configuration Summary	6
3.1. Absolute Maximum Ratings	9
3.2. General Operating Conditions	9
3.3. Environmental	10
3.4. Current Consumption	11
3.5. Energy Modes Transitions	18
3.6. Power Management	19
3.7. Flash	19
3.8. GPIO	20
3.9. LFXO	27
3.10. Minimum Load Capacitance (C _{LFXOL}) Requirement For Safe Crystal Startup	27
3.11. HFXO	28
3.12. LFRCO	28
3.13. HFRCO	30
3.14. ULFRCO	33
3.15. ADC	33
3.16. DAC	41
3.17. ACMP	43
3.18. VCMP	45
3.19. Digital Peripherals	45
4.1. Device Pinout	47
4.2. Alternate functionality overview	49
4.3. GPIO Pinout	51
4.4. QFP48 (Dimensions in mm)	52
5.1. QFP48 PCB Land Pattern Dimensions (Dimensions in mm)	54
5.2. QFP48 PCB Solder Mask Dimensions (Dimensions in mm)	55
5.3. QFP48 PCB Stencil Design Dimensions (Dimensions in mm)	56

List of Equations

3.1. Total ACMP Active Current	43
3.2. VCMP Trigger Level as a Function of Level Setting	45

